

Dear Customer,

We are pleased that you have chosen a motorhome from **HYMER** and would like to thank you for the trust you have shown in our company.

This instruction manual is intended to help you get to know and use your new (motor)home. **It is essential that you read and comply with the safety instructions in chapter 2.**

Don't hesitate to contact our **HYMER** service centres if you have any questions. Their staffs are fully conversant with your vehicle and will be pleased to help in any way they can. Our list of **HYMER** service centres in Europe is updated regularly. You can obtain a copy of the latest edition from our customer service department or from your **HYMER** dealer.

This instruction manual also includes the warranty certificate for your vehicle. You will be receiving the warranty stamp shortly. Please paste this stamp into the field provided. To maintain the **HYMER** weatherproof guarantee against water ingress, your vehicle must be inspected by an authorised **HYMER** dealer or an authorised specialist workshop once a year. A small fee will be charged for this inspection and a confirmation stamp stuck into this manual. We also recommend a general inspection of the conversion at yearly intervals.

The chassis manufacturer is responsible for all warranty work on the chassis and engine parts. For this purpose, **HYMER AG** passes on the first day of registration to the chassis manufacturer (as given by your **HYMER** dealer). Please follow the chassis manufacturer's servicing requirements exactly to maintain the chassis warranty to the full.

HYMER vehicles built on FIAT chassis fall under FIAT Germany's mobility guarantee. Should you have any difficulties with your FIAT chassis please contact: ¹⁾

ADAC-Schutzversicherungs A.G.
Kennwort "FIAT"
Am Westpark 8
81373 München
Germany

Help line in Germany: 0130 4070 or 089 76764070

Help line for the rest of Europe: +49 89 76764070

or

Fiat Camper Assistance: 00800 3428 1111

Or of course any authorised FIAT workshop.

Wishing you many happy holidays in your **HYMER** motorhome.

You will also find **HYMER AG** on the Internet at: <http://www.hymer.com>.

Yours, **HYMER AG**

¹⁾ These details are accurate at the time of going to press.

**Please paste the
warranty stamp
in here.**

Confirmation:

I have today received the documents for the annual servicing intervals and the water ingress test for the stated model.

Date:

Selling dealer's signature and stamp

Customer's signature

Water ingress test

For the water ingress test your **HYMER** contract partner checks the complete construction of your vehicle at all composite locations, windows, skylights, service flaps and doors for tightness.

Important

The performance and the exact adherence to the intervals is decisive for the continuation of the 6 year weatherproof guarantee. The water ingress test must be carried out on an annual basis. The interval may be carried out max. six months before or six months after the date on which the test is due. For additional information concerning the 6 year weatherproof guarantee, please refer to the following text. Also your **HYMER** contract partner will be pleased to advise you.

Conditions for the **HYMER** 6 year weatherproof guarantee

The vehicle vendor gives guarantee for the following:

1. Scope of guarantee

Under certain prerequisites, the vendor guarantees that

- the necessary prerequisites according to Point 2 are available
- and the buyer has had all impermeability inspections carried out acc. to Point 3 continuously and on time,

that for the vehicle, for a period of six years, for motorhomes, up to a maximum of 100,000 km, with normal use, no rain water will penetrate the body manufactured by **HYMER AG** through the connections, bored holes, and joints in the floor, wheel housing, side wall, front wall, rear wall and roof, including alcoves.

2. Prerequisites of the guarantee

The guarantee presupposes

- that the vehicle area that is leaking is in the original condition or, if work has been carried out on it, then such jobs have been performed exclusively by the vendor or by an authorised **HYMER AG** dealer or service centre;
- that there was no improper handling or overload;
- that the vehicle was not exposed to environmental pollution which exceeds that which is normal and permissible,
- that the **HYMER AG** care instructions and the operating instructions were adhered to;
- that the purchaser immediately handed over the vehicle for remedy of a detected fault to the vendor or to an authorised **HYMER AG** dealer or service centre.

The individual prerequisites will not be considered if they are not the cause or contributory cause for the leakage. Prerequisite for the enforcement of the guarantee is that the purchaser reported any leakage detected in the vehicle or any evidence of dampness indicating this leakage to the vendor latest 14 days after detection and made available the vehicle for repair, as far as long this was not unreasonable.

3. Annual inspection

The purchaser shall send the vehicle regularly, every year, to the vendor or to an authorised **HYMER AG** dealer or service centre for inspection. **The purchaser shall bear the cost of the inspection.** The first inspection must be conducted within the first year after delivery of the vehicle to the purchaser, however, latest within the first year from the date of initial registration of the vehicle. The subsequent annual inspections must be conducted by the calendar, corresponding to the latest date for the first inspection.

If the inspection is carried out six months after expiry of the period at the latest, then the right to claim under the guarantee remains in force, otherwise it is invalid. The time for the next inspection shall not be postponed by a delayed inspection. The inspections are to be proven by means of the guarantee stamps pasted into the guarantee booklet, with the date, stamp and signature from the workshops.

4. Guarantee period

The guarantee period commences with the delivery of the vehicle to the purchaser, on the date of the initial registration at the latest. It terminates prematurely when the vehicle is written off or its capability of use ceases to exist for other reasons. Work carried out on the vehicle which does not fall under this guarantee do not extend the guarantee period.

5. Guarantees

Any leakage covered by the guarantee will be remedied by the vendor. Should the remedy not succeed and the party covered by the guarantee cannot be reasonably expected to accept additional guarantees provided by the vendor, then the party covered by the guarantee can have the leakage remedied by **HYMER AG**, at the expense of the vendor. No further claims apply.

The vendor is not required to remedy the leakage when the vehicle is written off or its capability of use ceases to exist for other reasons as well as when the costs for the guarantee work exceed the value of the vehicle at that time.

A change of ownership has no effect on this guarantee.

6. Other claims

Claims made by the purchaser especially with respect to any performance, damage claims or warranty and guarantee claims made against the vendor or claims resulting from product liability are not affected by this guarantee. As far as the purchaser's duty of disclosure are required as part of this agreement, they refer exclusively to any claims from this guarantee.

7. Statute of limitations

The claims with respect to the remedying of a leakage falls under the statute of limitations 6 months after discovery of the leakage or dampness indicating this leakage, upon expiry of the guarantee period at the latest.

Inspection

After each service, the inspection plan provides you with supplementary and detailed information concerning the work which has been specifically carried out on your vehicle. You receive the inspection checklist when you collect your vehicle from your **HYMER** contract partner. Should it be determined during an inspection that additional work is necessary, then the carrying out of this work

is dependent on the customer commissioning this to be done. Please also adhere to the service intervals stipulated by the manufacturers of the individual equipment. Information is included in the service documents enclosed.

Important The carrying out of the planned inspections is a prerequisite for any guarantee claims.

Inspection record for a motorhome or caravan**Body inspection 1**

12 months after delivery

Date:

Mileage reading:

Dealer's signature and stamp:

Should it be determined during an inspection that additional work is necessary, then the carrying out of this work is dependent on the customer commissioning this to be done. Please also adhere to the service intervals stipulated by the manufacturers of the individual equipment. Information is included in the service documents enclosed.

Water ingress test 1**Water ingress test:**

Paste in the inspection stamp for the 12 month check here (subject to payment).

Liable to charges

12 months

Your next water ingress test is due on:

Earliest:

Latest:

Inspection record for a motorhome or caravan**Body inspection 2**

24 months after delivery

Date:

Mileage reading:

Dealer's signature and stamp:

Should it be determined during an inspection that additional work is necessary, then the carrying out of this work is dependent on the customer commissioning this to be done. Please also adhere to the service intervals stipulated by the manufacturers of the individual equipment. Information is included in the service documents enclosed.

Water ingress test 2**Water ingress test:**

Paste in the inspection stamp for the 12 month check here (subject to payment).

Liable to charges

24 months

Your next water ingress test is due on:

Earliest:

Latest:

Inspection record for a motorhome or caravan

Body inspection 3

36 months after delivery

Date:

Mileage reading:

Dealer's signature and stamp:

Should it be determined during an inspection that additional work is necessary, then the carrying out of this work is dependent on the customer commissioning this to be done. Please also adhere to the service intervals stipulated by the manufacturers of the individual equipment. Information is included in the service documents enclosed.

Water ingress test 3

Water ingress test:

Paste in the inspection stamp for the 12 month check here (subject to payment).

Liable to charges

36 months

Your next water ingress test is due on:

Earliest:

Latest:

Inspection record for a motorhome or caravan

Body inspection 4

48 months after delivery

Date:

Mileage reading:

Dealer's signature and stamp:

Should it be determined during an inspection that additional work is necessary, then the carrying out of this work is dependent on the customer commissioning this to be done. Please also adhere to the service intervals stipulated by the manufacturers of the individual equipment. Information is included in the service documents enclosed.

Water ingress test 4

Water ingress test:

Paste in the inspection stamp for the 12 month check here (subject to payment).

Liable to charges

48 months

Your next water ingress test is due on:

Earliest:

Latest:

Inspection record for a motorhome or caravan**Body inspection 5**

60 months after delivery

Date:

Mileage reading:

Dealer's signature and stamp:

Should it be determined during an inspection that additional work is necessary, then the carrying out of this work is dependent on the customer commissioning this to be done. Please also adhere to the service intervals stipulated by the manufacturers of the individual equipment. Information is included in the service documents enclosed.

Water ingress test 5**Water ingress test:**

Paste in the inspection stamp for the 12 month check here (subject to payment).

Liable to charges

60 months

Your next water ingress test is due on:

Earliest:

Latest:

Inspection record for a motorhome or caravan**Body inspection 6**

6 years after delivery

Date:

Mileage reading:

Dealer's signature and stamp:

Should it be determined during an inspection that additional work is necessary, then the carrying out of this work is dependent on the customer commissioning this to be done. Please also adhere to the service intervals stipulated by the manufacturers of the individual equipment. Information is included in the service documents enclosed.

Body inspection 7

7 years after delivery

Date:

Mileage reading:

Dealer's signature and stamp:

Inspection record for a motorhome or caravan

Body inspection 8

8 years after delivery

Date:

Mileage reading:

Dealer's signature and stamp:

Body inspection 9

9 years after delivery

Date:

Mileage reading:

Dealer's signature and stamp:

Should it be determined during an inspection that additional work is necessary, then the carrying out of this work is dependent on the customer commissioning this to be done. Please also adhere to the service intervals stipulated by the manufacturers of the individual equipment. Information is included in the service documents enclosed.

Inspection record for a motorhome or caravan

Body inspection 10

10 years after delivery

Date:

Mileage reading:

Dealer's signature and stamp:

Body inspection 11

11 years after delivery

Date:

Mileage reading:

Dealer's signature and stamp:

Should it be determined during an inspection that additional work is necessary, then the carrying out of this work is dependent on the customer commissioning this to be done. Please also adhere to the service intervals stipulated by the manufacturers of the individual equipment. Information is included in the service documents enclosed.

1	Introduction	17	4.18	Checking the oil level	51
1.1	General	18	4.19	Filling up with diesel	51
1.2	Environmental tips	18	4.20	Towing	51
2	Safety	21	5	Pitching the motorhome	53
2.1	Fire prevention	21	5.1	Handbrake	53
2.1.1	Avoidance of fire risks	21	5.2	Entrance step	53
2.1.2	Fire-fighting	21	5.3	Wheel chocks	53
2.1.3	In case of fire	21	5.4	Supports	53
2.2	General	22	5.4.1	General instructions	53
2.3	Road safety	22	5.4.2	Steady legs	54
2.4	Towing	24	5.5	240 V connection	54
2.5	Gas system	24	5.6	Refrigerator	54
2.5.1	General instructions	24	5.7	Awning	55
2.5.2	Gas bottles	25	6	Living	57
2.6	Electrical system	26	6.1	Doors	57
2.7	Water system	26	6.1.1	Conversion door, outside	57
3	Before the journey	27	6.1.2	Conversion door, inside	58
3.1	Initial start-up	27	6.1.3	Driver's door, outside	58
3.2	Payload	27	6.1.4	Driver's door, inside	59
3.2.1	Terms	28	6.1.5	Insect screen on the conversion door, extendable	59
3.2.2	Calculating the payload	30	6.2	External flaps	59
3.2.3	Loading the vehicle correctly	31	6.2.1	Flap lock, elliptical-shaped	60
3.2.4	Roof load	32	6.2.2	Underfloor sliding drawer	61
3.2.5	Rear garage/rear storage space	34	6.3	Ventilation	61
3.2.6	Underfloor sliding drawer	35	6.4	Windows	62
3.2.7	Bike rack	35	6.4.1	Sliding window without lock	63
3.3	Towing	36	6.4.2	Hinged window with automatic hinges	63
3.4	Entrance step	36	6.4.3	Hinged sunroof with automatic hinges	64
3.5	TV unit	37	6.4.4	Roman shade and insect screen	65
3.6	Sink cover	38	6.4.5	Roman shade and insect screen (hinged sunroof)	66
3.7	Snow chains	38	6.4.6	Blind for windscreen	66
3.8	Road safety	39	6.4.7	Roman shades for driver's window and front passenger's window	67
4	During the journey	41	6.5	Skylights	67
4.1	Driving the motorhome	41	6.5.1	Hinged skylight	68
4.2	Driving speed	42	6.5.2	Wind-up skylight	69
4.3	Parking distance control	42	6.6	Rotating seats	70
4.4	Curve light/fog light	43	6.7	Fixed table with rigid table leg	71
4.5	Brakes	44	6.8	TV unit	72
4.6	Seat belts	44	6.8.1	Positioning the flat screen	72
4.6.1	Fastening the seat belt correctly	44	6.8.2	Equipment with automatic antenna alignment	73
4.7	Child restraint systems	45	6.9	Beds	74
4.8	Driver's seat and front passenger's seat	45	6.9.1	Pull-down bed	74
4.9	Headrests	47	6.9.2	Pull-down bed, electrically operated	75
4.10	Seating arrangement	47	7	Gas system	79
4.11	Electrical window winder	47	7.1	General	79
4.12	Electrically adjustable external mirrors	48	7.2	Gas bottles	80
4.13	Blind for windscreen	48	7.3	Changing gas bottles	81
4.14	Roman shades for driver's window and front passenger's window	49			
4.15	Writing and reading rest	49			
4.16	Bonnet	50			
4.17	Filling with washer fluid	50			

7.4	Gas isolator taps	82	9.5.2	Operation (Dometic 7 series with automatic power selection and frame heater)	122
7.5	External gas connection.	82	9.5.3	Operation (Dometic 8 series with manual power selection MES)	124
7.6	DuoControl switching facility	83	9.5.4	Operation (Dometic 8 series with automatic power selection).	126
8	Electrical system	85	9.5.5	Refrigerator door locking mechanism	128
8.1	General safety instructions	85	10	Sanitary fittings	131
8.2	Terms.	85	10.1	Water supply, general.	131
8.3	12 V power supply	86	10.2	Water tank	132
8.3.1	Installation of inverter.	86	10.2.1	Drinking water filler neck with flap . . .	132
8.3.2	Starter battery	87	10.2.2	Filling with water.	133
8.3.3	Living area battery	88	10.2.3	Closing/opening the safety overflow	133
8.4	Transformer/rectifier (EBL 99)	90	10.2.4	Draining water (handle with safety overflow).	134
8.4.1	Battery cut-off switch	92	10.3	Waste water tank	134
8.4.2	Battery selector switch.	92	10.4	Filling the water system	135
8.4.3	Battery monitor.	92	10.5	Emptying the water system	136
8.4.4	Charging the battery	92	10.6	Toilet compartment.	136
8.4.5	Retrofitting additional 12 V appliances	93	10.7	Toilet.	137
8.5	Panel (LT 95)	93	10.7.1	Swivel toilet.	137
8.5.1	Switching the 12 V power supply On/Off	94	10.7.2	Toilet with fixed seat.	138
8.5.2	Battery voltage display.	94	10.7.3	Emptying the sewage tank	139
8.5.3	Displaying the tank water level	95	10.7.4	Winter operation	139
8.5.4	Alarms	96	10.7.5	Temporary lay-up	140
8.6	240 V power supply	97	10.8	Position of the drain cocks and safety/drainage valve	140
8.6.1	240 V connection.	97	11	Care	141
8.6.2	Power cable for external 240 V connection	97	11.1	External care	141
8.7	Fuses	98	11.1.1	General.	141
8.7.1	12 V fuses	98	11.1.2	Washing with a high-pressure cleaner	141
8.7.2	240 V fuse	102	11.1.3	Washing the vehicle	142
8.8	Circuit diagrams.	103	11.1.4	Windows of acrylic glass	142
8.8.1	Block diagram 240 V	103	11.1.5	Add-on parts made of glass-fibre reinforced plastic (GRP)	142
8.8.2	Block diagram 12 V	104	11.1.6	Underbody	143
9	Appliances	105	11.1.7	Waste water tank	143
9.1	General	105	11.1.8	Entrance step	143
9.2	Heater	105	11.2	Interior care	143
9.2.1	Models with waste gas vent on the right-hand side of the vehicle.	106	11.3	Cushions.	144
9.2.2	To heat properly.	106	11.4	Water system	146
9.2.3	Truma hot-air heater	106	11.4.1	Cleaning the water tank	146
9.2.4	Alde hot-water heater.	108	11.4.2	Cleaning the water pipes	146
9.2.5	Independent vehicle heater	113	11.4.3	Disinfecting the water system.	147
9.2.6	Auxiliary heat exchanger	114	11.5	Winter care	147
9.3	Boiler	114	11.6	Lay-up.	148
9.3.1	Models with waste gas vent on the right-hand side of the vehicle.	115	11.6.1	Temporary lay-up	148
9.3.2	Truma boiler.	115	11.6.2	Winter lay-up	149
9.3.3	Alde boiler	118	11.6.3	Starting up the vehicle after a temporary lay-up or after lay-up over winter	150
9.4	Cooker	119			
9.4.1	Gas cooker.	119			
9.4.2	Gas oven	121			
9.5	Refrigerator	121			
9.5.1	Refrigerator ventilation grill	122			

12	Customer service and maintenance	153	14.6.3	Dometic 8 series with AES	182
12.1	Inspection work	153	14.7	Water supply	183
12.2	Maintenance work	153	14.8	Body	184
12.3	Alde hot-water heater	153	15	Special equipment	185
12.3.1	Checking the fluid level	154	15.1	Weight details for special equipment	185
12.3.2	Topping up heating fluid	154	16	Technical data	187
12.3.3	Bleeding the heating system	155	16.1	Technical data	187
12.4	Independent vehicle heater	155			
12.5	Replacing bulbs, external	155			
12.5.1	Front lights	156			
12.5.2	Rear lights	159			
12.5.3	Side lights	159			
12.5.4	Types of bulbs for exterior lighting	160			
12.6	Replacing bulbs, internal	160			
12.6.1	Halogen spotlight	161			
12.6.2	Recessed halogen light (flat)	161			
12.6.3	Recessed halogen light	162			
12.6.4	Garage light	162			
12.6.5	Changing the battery of the wardrobe light with LEDs	163			
12.6.6	Types of bulbs for interior lighting	163			
12.7	Spare parts	163			
12.8	Vehicle identification plate	164			
12.9	Warning and information stickers	165			
12.10	Dealers	165			
12.11	Replacement key	165			
13	Wheels and tyres	167			
13.1	General	167			
13.2	Tyre selection	168			
13.3	Tyre specifications	169			
13.4	Handling of tyres	169			
13.5	Changing wheels	169			
13.5.1	General instructions	169			
13.5.2	Tightening torque	170			
13.5.3	Changing a wheel	170			
13.5.4	Changing a wheel at alloy wheel rims	171			
13.6	Spare wheel support	171			
13.7	Tyre pressure	172			
14	Troubleshooting	175			
14.1	Braking system	175			
14.2	Electrical system	175			
14.3	Gas system	177			
14.4	Gas cooker/gas oven	178			
14.5	Heater/boiler	178			
14.5.1	Truma heater/boiler	178			
14.5.2	Alde heater/boiler	179			
14.6	Refrigerator	179			
14.6.1	Dometic refrigerator 7 series with AES	180			
14.6.2	Dometic 8 series with MES	181			

Observe the following instructions before first journey of the vehicle:

- ▶ **Re-tighten the wheel nuts/wheel bolts after 50 km (30 miles).**
- ▶ **Read the instruction manual to avoid personal and material damage.**

Observe the following instructions before each journey of the vehicle:

- ▶ **Check the tyre pressures.**
See Tyre pressure section.
- ▶ **Load the vehicle correctly. Observe the maximum permissible gross weight.**
See Payload section.
- ▶ **Fully charge batteries before each journey.**
See Starter battery and Living area battery sections.
- ▶ **In case of external temperatures below 0 °C first heat vehicle, then fill water system.**
See Water supply/Filling the water tank section.
- ▶ **Gas bottles should only be transported within the designated gas bottle compartment and should be checked to be secure and in the off position prior to travelling.**
- ▶ **Keep forced ventilations clear.**
See Skylights and Ventilation sections.
- ▶ **Before filling the vehicle with fuel switch off gas-operated appliances.**

If there is any risk of frost, observe the following instructions:

- ▶ **If there is any risk of frost, always heat the vehicle.**
See Heater section.
- ▶ **If the vehicle is not being used when there is risk of frost, empty the entire water system. Leave the water taps on in central position. Leave the safety/drainage valve (Truma) and all drain cocks open. This will avoid frost damage to appliances and to the vehicle.**
See Emptying the water system section.

Please read this instruction manual completely before using the vehicle for the first time!

Always keep this instruction manual in the vehicle. Also inform all other users of the safety regulations.



▶ The non-observance of this symbol can lead to personal injury.



▷ The non-observance of this symbol can lead to damage being caused to, or inside the vehicle.



▷ This symbol indicates recommendations or special aspects.



▷ This symbol indicates actions which lead to environmental awareness.

This instruction manual contains sections which describe model-specific equipment or special equipment. These sections are not specially marked. It may be that your vehicle has not been fitted with this special equipment. In some cases, the actual equipment of your vehicle may therefore be different from that shown in some illustrations and descriptions.

However, your vehicle may be fitted with other special equipment not described in this instruction manual.

Special equipment is described when an explanation is required.

Adhere to the instruction manuals which are separately enclosed.



▷ The details "right", "left", "front" and "rear" always refer to the vehicle in direction of travel.

▷ All dimensions and weight details are "approximate".

▷ The metric specifications are binding for physical dimensions.

Should the vehicle be subjected to damage due to a failure to follow the instructions in this instruction manual, then the warranty claim is deemed invalid.

Our vehicles are subjected to continuous development. Please understand that we reserve the right to alter the form, equipment and technology. Therefore, no claims can be made against the manufacturer as a result of the contents of this instruction manual. The equipment which was known and included at the time of going to press is described.

The reprinting, translation and copying, including extracts is not permitted without prior written authorisation from the manufacturer.

1.1 General

The vehicle is constructed in accordance with the latest technology and the recognised safety regulations. Nevertheless, personal injury may result and the vehicle may be damaged if the safety instructions in this instruction manual are not followed.

Only use the vehicle in a technically impeccable condition. Follow the instructions in the instruction manual.

Malfunctions which impair the safety of persons or the vehicle should be immediately remedied by qualified personnel. To avoid further damages, observe the duty to avert, minimise or mitigate loss for the user during faults.

Have the vehicle's braking and gas systems inspected and repaired by an authorised specialist workshop only.

Alterations to the body are only to be carried out with the authorisation of the manufacturer.

The vehicle is designed for the exclusive transport of persons. Luggage and accessories may only be transported up to the maximum permissible gross weight.

Observe the test and inspection periods stipulated by the manufacturer.

1.2 Environmental tips



- ▷ Be considerate of the environment.
- ▷ Remember that: All kinds of waste water and household waste are not to be disposed of in drains or in the open countryside.
- ▷ On board, collect waste water only in the waste water tank or – if necessary – in other containers designed for that purpose.
- ▷ Only empty the waste water tank and sewage tank at disposal stations, camping sites or caravan sites especially provided for this purpose. When stopping in towns and communities, observe the instructions at caravan sites or ask where there are disposal stations.
- ▷ Empty waste water tank as often as possible, even when it is not completely full (hygiene).
If possible, flush out waste water tank and, if necessary, drainage pipe with fresh water every time it is emptied.
- ▷ Never allow the sewage tank to become too full. Empty the sewage tank frequently, at the latest as soon as the filling level display lights up.
- ▷ Separate household waste according to glass, tin cans, plastic and wet waste also when on a journey. Enquire at the town or community authority about disposal points. Household waste is not to be disposed of in waste paper baskets which are situated at car parks.
- ▷ Empty waste bins as often as possible into the containers provided for this purpose. This helps to avoid unpleasant smells and an accumulation of rubbish on board.
- ▷ When parked, do not allow the engine to run more than necessary. When running idle, a cold engine releases more contaminants than usual. The running temperature of the engine is achieved more quickly whilst the vehicle is in motion.
- ▷ Use an environmentally-friendly WC chemical agent for the WC which can also be biologically degraded and only use small doses.



- ▷ When staying in towns and communities for long periods, search for parking areas which are specially reserved for motorhomes. Enquire at the town or community authority about parking spaces.
- ▷ Always leave the parking places in a clean condition.

Chapter overview

This chapter contains important safety instructions. The safety instructions are for the protection of persons and property.

The instructions address the following topics:

- fire prevention and what to do in case of fire
- general care of the vehicle
- road safety of the vehicle
- towing
- gas system of the vehicle
- electrical system of the vehicle
- water system of the vehicle

2.1 Fire prevention

2.1.1 Avoidance of fire risks



- ▶ Never leave children in the vehicle unattended.
- ▶ Keep flammable materials clear of heating and cooking appliances.
- ▶ Lights can get very hot. When the light is switched on, there must always be a safety distance of 30 cm between light and flammable objects. Fire hazard!
- ▶ Never use portable heating or cooking appliances.
- ▶ Only authorised qualified personnel may make changes to the electrical system, gas system or appliances.

2.1.2 Fire-fighting



- ▶ Always carry a dry powder fire extinguisher in the vehicle. The fire extinguisher must be approved, tested and close at hand.
- ▶ Have the fire extinguisher tested at regular intervals by authorised qualified personnel. Observe the date of testing.
- ▶ Always keep a fire blanket near the cooker.

2.1.3 In case of fire



- ▶ Evacuate all passengers.
- ▶ Cut off the electrical power supply and disconnect from the mains.
- ▶ Close regulator tap on the gas bottle.
- ▶ Sound the alarm and call the fire brigade.
- ▶ Fight the fire if this is possible without risk.



- ▷ Acquaint yourself with the position and operation of the emergency exits.
- ▷ Keep escape routes clear.
- ▷ Observe the fire extinguisher instructions for use.

All windows and doors which meet the following requirements are considered as emergency exits:

- Open to the outside or can be shifted in horizontal direction
- Opening angle at least 70°

- Minimum diameter of clearance = 450 mm
- Maximum distance from the vehicle floor = 950 mm

2.2 General



- ▶ The oxygen in the vehicle interior is used up by breathing and the use of gas operated appliances. That is why the oxygen needs to be replaced on a constant basis. For this purpose, forced ventilation options (e.g. skylights with forced ventilation, mushroom-shaped vents or floor vents) are fitted to the vehicle. Never cover or block forced ventilations from the inside or outside with objects such as e.g. a winter mat. Keep forced ventilations clear of snow and leaves. There is a danger of suffocation due to increased CO₂ levels.
- ▶ Observe the headroom of the doors.



- ▷ As far as the fitted appliances (heater, cooker, refrigerator, etc.) and the base vehicle (engine, brakes, etc.) are concerned, the instruction manuals are authoritative. It is imperative that they be observed.
- ▷ Fitting accessories or special equipment can alter the dimensions, weight and road behaviour of the vehicle. Some of the parts must be entered in the vehicle papers.
- ▷ Only use wheel rims and tyres which are approved for the vehicle. Information concerning the size of the approved wheel rims and tyres is included in the vehicle documents or can be obtained from authorised dealers and service centres.
- ▷ Firmly apply the handbrake when parking the vehicle.
- ▷ If the maximum permissible gross weight of the vehicle exceeds 4 tonnes, wheel chocks must be used when parking on gradients. The wheel chocks are provided as standard for vehicles with a maximum permissible gross weight exceeding 4 tonnes.



- ▷ When leaving the vehicle, it is imperative that all doors, external flaps and windows are closed.
- ▷ Carry a hazard warning triangle and a first-aid kit and/or flashing hazard warning light when this is required by law.
- ▷ The vehicle may only be driven by drivers who hold a driving licence which is valid for the respective vehicle class.
- ▷ When selling the vehicle, hand over all instruction manuals for the vehicle and the fitted appliances.

2.3 Road safety



- ▶ Before commencing the journey, carry out a functional check of indicating and lighting equipment, the steering and the brakes.
- ▶ If the vehicle has been stationary for a long period (approx. 10 months) have the braking and gas systems checked by an authorised specialist workshop.
- ▶ Before commencing the journey and after short interruptions of the journey, ensure that the entrance step is completely retracted.
- ▶ Before commencing the journey, secure the hinged pull-down bed.



- ▶ Before commencing the journey, open, lock and secure the shades situated on the windscreen and on the driver's and front passenger's windows.
- ▶ Before commencing the journey, rotate all swivel seats in the direction of travel and lock in position. During the journey, the swivel seats must remain locked in place in the direction of travel.
- ▶ Before commencing the journey, store the television securely.
- ▶ Before commencing the journey, push the television console in and let it lock into place or secure it. Close the TV cabinet.
- ▶ Before commencing the journey, take off the loose sink and drain basin covers and store them securely in the kitchen unit or the wardrobe.
- ▶ During the journey, persons are only to sit on the permitted seats (see chapter 4). The authorised number of seats is stipulated in the vehicle documents.
- ▶ Seat belts must be worn by all passengers.
- ▶ Fasten your seat belts before the beginning of the journey and keep them fastened during the journey.
- ▶ Always secure children with the children safety equipment prescribed for the respective height and weight.
- ▶ Factory-set three-point safety belts must be used when attaching child restraint systems.
- ▶ The base vehicle is a commercial vehicle (small truck). Adjust your driving technique accordingly.
- ▶ In case of underpasses, tunnels or similar obstacles, note the total height of the vehicle (including the roof load).
- ▶ In winter, the roof must be free of snow and ice before commencing the journey.
- ▶ Check tyre pressure before a journey or every 2 weeks. Wrong tyre pressure causes excessive wear and can lead to damage or even to tyre burst. You can lose control of the vehicle.
- ▶ Do not operate the independent vehicle heater at petrol stations. Danger of explosion!
- ▶ Do not operate the independent vehicle heater in closed spaces. Danger of suffocation!



- ▷ Before commencing the journey, distribute the payload evenly within the vehicle (see chapter 3).
- ▷ When loading the vehicle and when taking a rest from driving, in order to load luggage or food, for example, observe the maximum permissible gross weight and axle loads (refer to vehicle documents).
- ▷ Before commencing the journey, close and lock, if possible, all inner doors, adjustable partition walls, drawers and flaps. Engage the refrigerator door securing device.
- ▷ Before commencing the journey, close windows and skylights.
- ▷ Before commencing the journey, close all external flaps and lock them.
- ▷ Before commencing the journey, remove the external supports and retract the corner steadies or steady legs, which are fitted to the vehicle.
- ▷ Before commencing the journey, put the antenna in park position.



- ▷ During the initial journey and each time after changing a wheel, re-tighten the wheel bolts/wheel nuts after 50 km (30 miles). Subsequently inspect them at regular intervals in order to ensure that they are firmly seated. See chapter 13 for tightening torque.
- ▷ Tyres may not be older than 6 years as the material becomes brittle over time (see chapter 13).
- ▷ When using snow chains, the tyres, wheel suspension and steering are subjected to an additional load. When using snow chains, drive slowly (maximum speed 50 km/h) and only on streets which are completely covered with snow. Otherwise the vehicle could be damaged.

2.4 Towing



- ▶ Care is to be taken when connecting and detaching a trailer. Risk of accident and injury!
- ▶ No persons are to be between the motorhome and the trailer during positioning for connecting and detaching.

2.5 Gas system

2.5.1 General instructions



- ▶ Before commencing the journey, when leaving the vehicle or when gas equipment is not in use, close all gas isolator taps and the main isolator tap on the gas bottle.
- ▶ No appliance operated by a naked flame (e.g. heater or refrigerator) may be in operation when filling the tank, on ferries or in the garage. Danger of explosion!
- ▶ Do not use appliances operated with a naked flame in closed spaces (e.g. garages). Danger of poisoning and suffocation!
- ▶ Only have the gas system maintained, repaired or altered by an authorised specialist workshop.
- ▶ Have the gas system checked by an authorised specialist workshop according to the national regulations before commissioning. This also applies for not registered vehicles. For modifications to the gas system have the gas system immediately checked by an authorised specialist workshop.
- ▶ The gas pressure regulator and exhaust gas pipes must also be inspected. The gas pressure regulator has to be replaced after 10 years at the latest. The vehicle owner is responsible for seeing that this is carried out.
- ▶ In case of a defect of the gas system (gas odour, high gas consumption) there is danger of explosion! Close regulator tap on the gas bottle immediately. Open doors and windows and ventilate well.
- ▶ If the gas system is defective: Do not smoke; do not ignite any open flames, and do not operate electric switches (light switches etc.).
- ▶ Before using the cooker make sure that there is sufficient ventilation. Open windows or the skylight.
- ▶ Do not use the gas cooker or gas oven for heating purposes.



- ▶ If there are several gas devices, each gas device must have its own gas isolator tap. If individual gas devices are not in use, close the respective gas isolator tap.
- ▶ Ignition safety valves must close within 1 minute after the gas flame has extinguished. A clicking sound is audible. Check function from time to time.
- ▶ The built-in gas devices are exclusively meant for use with propane or butane gas or a mixture of both. The gas pressure regulator as well as all built-in gas devices are designed for a gas pressure of 30 mbar.
- ▶ Propane gas is capable of gasification up to -42 °C, whereas butane gas gasifies at 0 °C. Below these temperatures no gas pressure is available. Butane gas is unsuitable for use in winter.
- ▶ Regularly inspect the gas tube fitted to the gas bottle connection for tightness. The gas tube must not have any tears and must not be porous. Have the gas tube replaced by an authorised specialist workshop no later than ten years after the manufacturing date. The operator of the gas system must see to it that the parts are replaced.
- ▶ Due to its function and construction, the gas bottle compartment is a space which is open to the exterior. Never cover or block up the standard forced ventilations. Otherwise gas that is emitted can not be diverted to the outside.
- ▶ Do not use the gas bottle compartment as storage space as it is not moisture-proof.
- ▶ Secure the gas bottle compartment against unauthorised access. To do this, lock the compartment.
- ▶ The regulator tap on the gas bottle must be accessible.
- ▶ Only connect gas-operated devices (e.g. gas grill) which have been designed for a gas pressure of 30 mbar.
- ▶ The exhaust gas pipe must be fitted tightly to the heating system and to the vent and must be sealed. The exhaust gas pipe must not show any evidence of damage.
- ▶ Exhaust fumes must be able to escape into the atmosphere unhindered and fresh air must be able to enter unhindered. For this reason, keep the exhaust pipe and intake openings clean and unobstructed (e.g. free from snow and ice). For this reason, no snow walls or aprons may lie against the vehicle.

2.5.2 Gas bottles



- ▶ Gas bottles are only to be transported within the designated gas bottle compartment.
- ▶ Place the gas bottles in vertical position in the gas bottle compartment.
- ▶ Fasten the gas bottles so that they are unable to turn or tilt.
- ▶ If the gas bottles are not connected to the gas tube, always place the protective cap on top.
- ▶ Close the regulator tap on the gas bottle before the gas pressure regulator or gas tube are removed from the gas bottle.
- ▶ The gas pressure regulator or the gas tube must only be secured with a suitable gas spanner (Do **not** overtighten).



- ▶ Only use special gas pressure regulators with a safety valve designed for vehicle use. Other gas pressure regulators are not permitted and cannot meet the demanding requirements.
- ▶ Use the gas pressure regulator defroster if the temperature falls below 5 °C.
- ▶ The designated gas bottle compartment will accommodate two gas bottles, i. e. Calor Gas Butane/Propane or Camping Gaz. All gas bottles **must** be fitted with the appropriate regulator.
- ▶ Use the shortest possible tube lengths (150 cm max.) for external gas bottles.
- ▶ Never block the floor ventilation openings below the gas bottles.

2.6 Electrical system



- ▶ Only allow qualified personnel to work on the electrical system.
- ▶ Prior to carrying out work on the electrical system, switch off all devices and lights, disconnect the battery and disconnect the vehicle from the mains.
- ▶ Only use original fuses with the stipulated values.
- ▶ Only replace defective fuses when the cause of the defect is known and has been remedied.
- ▶ Never bridge or repair fuses.

2.7 Water system



- ▶ Water left standing in the water tank or in the water pipes becomes undrinkable after a short period. Therefore, before each use of the vehicle, thoroughly clean the water pipes and the water tank. After each use of the vehicle completely empty the water tank and the water pipes.
- ▶ In the case of lay-ups lasting more than a week disinfect the water system before using the vehicle.



- ▶ If the vehicle is not used for several days or if it is not heated when there is a risk of frost, empty the entire water system. Leave the water taps on in central position. Leave the safety/drainage valve (Truma) and all drain cocks open. Frost damage to appliances, frost damage to the vehicle and deposits in water-carrying components can be avoided in this way.

Chapter overview

This chapter contains important information which has to be noted before commencing your journey or carrying out any tasks before the journey.

The instructions address the following topics:

- initial start-up
- calculating the payload
- correct loading of the vehicle and bike rack
- towing
- retracting and extending the entrance step
- storing the flat screen
- storing the sink cover
- using snow chains

At the end of the chapter there is a checklist which once again summarises the most important points.

3.1 Initial start-up



- ▷ During the initial journey and each time after changing a wheel, re-tighten the wheel bolts/wheel nuts after 50 km (30 miles). Subsequently inspect them at regular intervals in order to ensure that they are firmly seated. See chapter 13 for tightening torque.

The motorhome is supplied with a set of keys, consisting of keys for the base vehicle and keys for the body.

Always deposit a replacement key outside the vehicle. Make a note of the key number. Our authorised dealers and workshops can offer assistance in case of loss.

Further information in chapter 12.

3.2 Payload



- ▶ Overloading the vehicle and wrong tyre pressure can cause tyres to burst. You can lose control of the vehicle.
- ▶ Only the maximum permissible gross weight and the mass in a ready-to-drive condition, not the actual weight of the vehicle, is stated in the vehicle documents. For your own safety, we recommend that you have your loaded vehicle (with all passengers, luggage and personal objects) weighed on a public weighbridge before you set out on your journey.
- ▶ Adapt the speed to the payload. The stopping distance is increased if the payload is high.



- ▷ Do not exceed the maximum permissible gross weight stated in the vehicle documents by the payload.
- ▷ Built-in accessories and special equipment reduce the payload.
- ▷ Adhere to the axle load stated in the vehicle documents.

On loading, make sure that the payload's centre of gravity is as low as possible (directly above the floor of the vehicle). Otherwise this may affect the driving characteristics of the vehicle.

3.2.1 Terms



- ▷ Technically speaking, the term "mass" has now replaced the term "weight". However, "weight" is still the term more frequent in common use. For better understanding, "mass" is therefore only used in the following sections for fixed formulations.
- ▷ All specifications according to EU norm DIN EN 1646-2.

Maximum permissible gross weight in a laden condition

The maximum permissible gross weight in a laden condition is the weight that a vehicle may never exceed.

The maximum permissible overall weight in laden condition consists of the **mass in ready-to-drive condition** and of the **payload**.

In the vehicle documents, the manufacturer has specified the maximum permissible gross weight in a laden condition.

Permitted mass

The permitted mass is the weight specified by the manufacturer for issuing the type approval. The permitted mass must never exceed the maximum permissible gross weight of the loaded vehicle.

Mass in ready-to-drive condition

The mass in ready-to-drive condition is the weight of the ready-to-drive standard vehicle.

The mass in ready-to-drive condition is made up as follows:

- Unladen weight (mass of the empty vehicle) with factory-installed standard equipment
- Driver's weight
- Basic equipment weight

Unladen weight includes lubricants such as oils and coolants which have been filled, the on-board tool set, the spare wheel and a fuel tank which has been filled up to 90 %.

75 kg are calculated for the weight of the driver, regardless of how much the driver really weighs.

Basic equipment includes all equipment and fluids required for safe and proper vehicle use. The weight of the basic equipment includes:

- Water system filled up to 90 % (water tank and pipes)
- Gas bottles filled up to 90 %
- A full heating system
- The power cables for the 240 V power supply
- A full toilet flushing system
- The installation kit for an auxiliary battery if an auxiliary battery can be used

The waste water and sewage tanks are empty.

Example for calculating the basic equipment

Water tank with 120 l	120 kg
Gas bottles (2 x 11 kg _{gas} + 2 x 14 kg _{bottle})	+ 50 kg
Boiler with 12 l	+ 12 kg
240 V power cable	+ 4 kg
Installation kit for auxiliary battery	+ 20 kg
Total	= 206 kg

In the vehicle documents, the manufacturer specifies the mass in ready-to-drive conditions.

Payload The payload is made up as follows:

- Conventional load
- Additional equipment
- Personal equipment



▷ The vehicle's payload can be increased by reducing the weight in a ready-to-drive condition. To do this, it is allowed for example to empty the fluid containers or to remove the gas bottles.

You will find explanations on the individual components of the payload in the following text.

Conventional load

The conventional load is the weight specified by the manufacturer for the passengers.

Conventional load means: 75 kg are calculated for every seat specified by the manufacturer, regardless of how much the passengers actually weigh. The driver's seat is already included as part of the mass in ready-to-drive condition and must **not** be calculated as part of the conventional load.

In the vehicle documents, the manufacturer specifies the number of seats.



▷ More passengers may travel in the vehicle than specified in the vehicle documents if a seat is available for each person. The maximum permissible gross weight in a laden condition may however not be exceeded. The fluid containers may be emptied or the gas bottles may be removed to avoid exceeding the maximum permissible gross weight.

Additional equipment

Additional equipment includes accessories and special equipment. Examples of additional equipment include:

- Caravan coupling
- Roof rail
- Awning
- Bike or motorcycle rack
- Satellite unit
- Microwave oven

Chapter 15 lists the weights of the various items of special equipment; they may also be obtained from the manufacturer.

Personal equipment

Personal equipment includes all items in the vehicle that are not included in the conventional load or in the additional equipment. For example, personal equipment can include the following:

- Foodstuffs
- Crockery
- Television
- Radio
- Clothes
- Bedding
- Toys
- Books
- Toiletries

No matter where kept, personal equipment also includes:

- Animals
- Bikes
- Boats

- Surfboards
- Sports equipment

For the personal equipment, according to the applicable regulations, the manufacturer must use a minimum weight that is determined according to the following formula:

Formula Minimum weight M (kg) = 10 x N + 10 x L

Explanation N = maximum number of people including the driver, as stated by the manufacturer
L = total length of the vehicle in metres

3.2.2 Calculating the payload



- ▶ The payload calculation at the factory is partly based on all-inclusive weights. For safety reasons, the maximum permissible gross weight in a laden condition must not be exceeded.
- ▶ Only the maximum permissible gross weight and the mass in a ready-to-drive condition, not the actual weight of the vehicle, is stated in the vehicle documents. For your own safety, we recommend that you have your loaded vehicle (with all passengers, luggage and personal objects) weighed on a public weighbridge before you set out on your journey.

The payload (see section 3.2.1) is the difference in weight between

- Maximum permissible gross weight in a laden condition and
- Vehicle mass complete in a ready-to-drive condition.

Example for calculating the payload

	Mass in kg to be calculated	Calculation
Maximum permissible gross weight according to vehicle documents	3500	
Vehicle mass in a ready-to-drive condition, including basic equipment according to vehicle documents	- 3070	
This results in a permissible payload of	430	
Conventional load e.g.: 3 persons each weighing 75 kg	- 225	
Additional equipment	- 40	
For the personal equipment this results in	= 165	

The calculation of the payload from the difference between the maximum permissible gross weight in laden condition and the mass specified by the manufacturer in ready-to-drive condition is however only a theoretical value.

Only if the vehicle is weighed with full tanks (fuel and water), full gas bottles and complete additional equipment on a public weighbridge, can the actual payload be determined.

To do this, proceed as follows:

- First only drive the vehicle on to the weighbridge with the front wheels and have it weighed.
- Then drive the vehicle on to the weighbridge with the back wheels and have it weighed.

The individual values give the current axle loads. These are important for the correct loading of the vehicle (see section 3.2.3). The sum of these values is the current weight of the vehicle.

The actual payload is the difference between the maximum permissible gross weight in laden condition and the weighed vehicle weight.

This can be used to determine the weight that remains for the personal equipment:

- Determine the weight of the passengers and subtract it from the value for the actual payload.

The result is the weight that is permitted for the actual load of the personal equipment.

3.2.3 Loading the vehicle correctly



- ▶ For safety reasons, never exceed the maximum permissible gross weight in a laden condition.
- ▶ Distribute the load evenly on the left and right sides of the vehicle.
- ▶ Distribute the load evenly on both axles. In doing so, observe the axle loads specified in the vehicle documents. Observe the permissible load-carrying capacity of the tyres (see chapter 13).
- ▶ Heavy loads behind the rear axle can reduce the load on the front axle due to the leverage effect ($\frac{L}{L+G}$). This applies especially to long rear extensions, if a motorbike is transported on the rear carrier or if there is a heavy load in the rear storage space. The release of the front axle negatively affects the driving quality, especially for front-driven vehicles.
- ▶ Store all objects in such a way that they cannot slip.
- ▶ Store heavy objects (awning, tin cans, etc.) close to the axles. Low-lying storage compartments whose doors do not open in the direction of travel are particularly suited for storing heavy objects.
- ▶ Stack light objects (laundry) in the roof storage cabinets.
- ▶ Load the bike rack with bicycles only (max. four units).

Large storage spaces, such as the rear garage, also have room for heavy objects (e.g. motorcycle). This might mean that the axle load on the rear axle is exceeded.

However, the individual axles may not be overloaded under any circumstances. That is why it is important, at which distance to the axles the load is stored.

To distribute the load correctly, you will need a scale, a tape measure, a calculator and some time.

Two simple formulas are needed to calculate the effect of the weight of the load on the axles:

Formulas

$A \times G : R = \text{weight on the rear axle}$

$\text{Weight on the rear axle} - G = \text{weight on the front axle}$

Explanation

A = distance between storage compartment and front axle in cm
 G = weight of the load in the storage compartment in kg
 R = wheelbase of the vehicle (distance between axles) in cm



- ▷ Measure the external distances horizontally from the centre of the front wheel to the centre of the storage compartment or to the centre of the back wheel.

Calculating axle loads:

- Multiply the distance between storage compartment and front axle (A) with the weight of the load in the storage compartment (G) and divide the result by the wheelbase (R). The result is the weight of the load in the storage compartment on the rear axle. Make a note of this weight and of the storage compartment.
- In a second step, subtract the weight in the storage compartment (G) from the weight calculated beforehand. If the result is a **positive** value (example 1), this means that the load on the front axle is **reduced** by this value. If the result is a **negative** value (example 2), this means that the load on the front axle is **increased**. Make a note of this value, too.
- Calculate all storage compartments of the vehicle in the same way.
- In a last step, add all weights calculated for the rear axle to the rear axle load and add (or subtract) all weights calculated for the front axle to (from) the front axle load.
 How to determine rear axle load and front axle load is described in section 3.2.2.

If the calculated value exceeds the permissible axle load, the load must be distributed in a different way.

If the load on the front axle is too low, the grip of the tyres on the road is reduced (traction). This applies in particular to vehicles with front wheel drive. In this case, the load must be redistributed, too.

Example calculation

		Example 1	Example 2
Distance to the front axle	A	(A1) 450 (cm)	(A2) 250 (cm)
Weight in the storage compartment	G	x 100 (kg)	x 50 (kg)
Wheelbase of the vehicle	R	÷ 325 (cm)	÷ 325 (cm)
Load on the rear axle (add to the axle load)		138.5 (kg)	38.5 (kg)
Weight in the storage compartment		- 100 (kg)	- 50 (kg)
Load relief to the front axle (subtract from the axle load)		38.5 (kg)	
Load on the front axle (add to the axle load)			-11.5 (kg)

3.2.4 Roof load



- ▶ Only climb on to the roof if a roof rail or step has been fitted. Always use the ladder at the rear to climb onto the roof.
- ▶ Take care when stepping onto the ladder. There is danger of slipping when the ladder is moist or icy.



- ▶ Take care when stepping onto the roof. There is danger of slipping when the roof is moist or icy.
- ▶ Do not overload the roof. Road behaviour and brake reaction deteriorate as the roof load increases.



- ▷ If the vehicle is equipped with a roof rail, load racks can be mounted on the roof rail for roof loads (e.g. for surfboards, rubber boats or light canoes). Special girder systems are available as accessory. The authorised dealer or service centre will be happy to advise you.
- ▷ The maximum permissible roof load is 75 kg.
- ▷ The roof of the vehicle was designed for a maximum load of 75 kg/m². On the roof, walk only on the step provided for this purpose.
- ▷ Secure roof loads with tension belts. Do not use rubber expanders.
- ▷ Observe the overall height of the vehicle when the roof rack is loaded.



- ▷ The driver's cabin should have a clearly visible notice stating the overall height. This eliminates the need for calculations at bridges and thoroughfares.

Roof rail and step



Fig. 1 Roof rail and step

If the vehicle is equipped with a roof rail (Fig. 1,1), mount a step on the roof (Fig. 1,2). On the roof, walk only on the step.

Rear ladder



Fig. 2 Rear ladder lock

Folding downwards:

- Insert the key into the locking cylinder (Fig. 2,2) of the rear ladder lock (Fig. 2,1) and turn it a quarter turn until the key is in a vertical position.

- Hold the foldable part of the rear ladder (Fig. 2,4) and swing out the securing bracket (Fig. 2,5).
- Pull out the key and fold the rear ladder downwards.

Folding upwards:

- Fold the rear ladder upwards and hold it firmly.
- Insert the key into the locking cylinder (Fig. 2,2) of the rear ladder lock (Fig. 2,1).
- Swivel the securing bracket (Fig. 2,5) inward around the tube of the fixed part of the rear ladder (Fig. 2,3).
- Turn the key a quarter turn until it is in a horizontal position.
- Check the rear ladder lock: Slightly pull on the rear ladder.

3.2.5 Rear garage/rear storage space



- ▶ Observe the permissible axle loads and maximum permissible gross weight when loading the rear garage/the rear storage space.
- ▶ The maximum permitted load of the rear garage/the rear storage space is 350 kg. Do not exceed the permissible rear axle load.
- ▶ Observe: If the rear garage or (depending on the model) the rear storage space is **loaded** to its maximum capacity, this will **reduce the load** on the front axle due to the levering action. The driving quality is impaired.



- ▷ Depending on the vehicle equipment, clamping rails with clamping eyelets are mounted in the rear garage or in the rear storage space. Always secure loads onto the clamping eyelets. Always use tightening straps or lashing nets for securing the load, never rubber expanders.
- ▷ When clamping loads, always check that the clamping eyelets are placed tightly in the clamping rails. If the clamping eyelet is not anchored tightly in the clamping rail, the load may slide or loosen during forcible movements of the steering wheel or when braking.
- ▷ Distribute the load evenly. Excessive spot loads can lead to damages of the floor covering.
- ▷ Use the supporting system offered by your dealer if two-wheelers are transported in the rear garage.

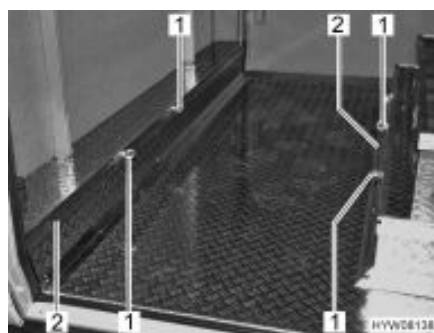

- 1 Clamping eyelet
- 2 Clamping rail

Fig. 3 Clamping eyelets rear garage

Moving the clamping eyelets:

- Turn the clamping eyelet (Fig. 3,1) half a turn in an anticlockwise direction.
- Push the clamping eyelet into the clamping rail (Fig. 3,2) to the desired position.

- Give clamping eyelet one half turn in a clockwise direction. The clamping eyelet sits tightly in the clamping rail again.
- Check that the clamping eyelet is tight.

3.2.6 Underfloor sliding drawer



- ▷ The maximum permitted underfloor sliding drawer load is 40 kg.

3.2.7 Bike rack



- ▶ Observe the permissible axle loads and maximum permissible gross weight when loading the bike rack.
- ▶ Bicycles may protrude at the side by a maximum of 40 cm, measured from the outer edge of the tail lights. However, a total width of 2.5 m must not be exceeded. Adjust the attachments for the bikes accordingly. The overhang must be marked with a red flag.
- ▶ Load the bike rack with bicycles only (max. four units).
- ▶ The "Multitalent" bike rack may be loaded with a maximum of four bicycles (max. 50 kg).
- ▶ Check the secure attachment of the bicycles on the bike rack after the first 10 km and then at each break in the journey.
- ▶ Do not use the bike rack as luggage rack or ladder.



- ▷ The identification plate and rear lights must not be covered.
- ▷ Driving with a folded out bike rack without bicycles is not permitted.
- ▷ Before every journey, check:
 - Is the bike rack without bicycles folded in correctly?
 - Are the bicycles securely fastened to the bike rack using the bike rack belts?

Loading the bike rack with bicycles

When loading the bike rack, observe the centre of gravity. The centre of gravity of the bicycles must be as close as possible to the rear wall of the vehicle. The bike rack should always be loaded from the inside to the outside.

Loading the bike rack correctly:

- Fold the bike rack downwards.
- Place the heaviest bicycle directly against the rear wall.
- Place the lightest bicycles in the centre or on the outside of the bike rack.
- Secure the front and rear wheels of each bicycle with the retaining straps on the bike rack.
- In addition, fasten the outermost bicycle on the retaining bracket or retaining arm.

If the bike rack is only loaded with **one** bicycle, position the bicycle as closely as possible to the rear wall.

3.3 Towing



- ▶ Care is to be taken when connecting and detaching a trailer. Risk of accident and injury!
- ▶ No persons are to be between the motorhome and the trailer during positioning for connecting and detaching.
- ▶ Observe the permissible nose weight and rear axle load of the motorhome. Nose weight and rear axle load must not be exceeded. The values of the nose weight and rear axle load are included in the documents of the vehicle and the caravan coupling.



- ▷ Trailer with an overrun brake: Do not connect or detach trailer with the overrun brake on.
- ▷ Caravan coupling with detachable ball neck: If the ball neck is mounted incorrectly, there is the danger of the trailer breaking away. Observe the instruction manual for the caravan coupling.

3.4 Entrance step



- ▶ Before commencing the journey and after short interruptions of the journey, ensure that the entrance step is completely retracted.
- ▶ Do not stand in the direct range of the entrance step while it is being retracted or extended.
- ▶ Do not step on the entrance step until it has extended completely. There is a risk of injury.
- ▶ Do not under any circumstances raise or lower persons or loads with the entrance step.



- ▷ Do not grease or lubricate the pivot bearing and joints of the entrance step (see chapter 11).

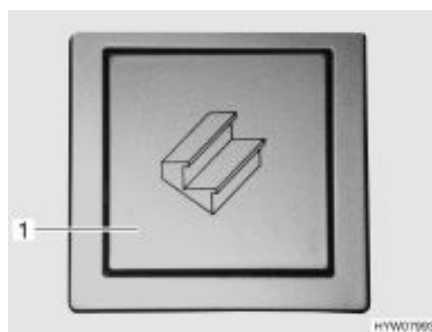

Fig. 4 Rocker switch for entrance step (entrance area)



Fig. 5 Rocker switch for entrance step (dashboard)

Retracting or extending:

- Press the rocker switch (Fig. 4,1) in the entrance area or the rocker switch (Fig. 5,1) on the dashboard in the driver's cabin.

When the engine is running and the entrance step is extended, a warning tone is heard. The warning tone ceases as soon as the entrance step is retracted.

3.5 TV unit



- ▶ Before commencing the journey, store the television securely.
- ▶ Before commencing the journey, turn the flat screen and the screen holder back to the basic position, push them in and secure them.
- ▶ Before commencing the journey, ensure that the antenna is in park position. Danger of accidents!



- ▷ If there is a risk of frost, do not leave the flat screen television in the vehicle.



- ▷ Further information on positioning the flat screen can be obtained from chapter 6.

Flat screen in the TV cabinet

The flat screen is attached to a console in the TV cabinet.



Fig. 6 Television (flat screen) in the TV cabinet

Storing the television in the TV cabinet:

- Return television into its initial position.
- Insert the holder for the flat screen until the latch (Fig. 6,1) locks into place.

Flat screen on jointed arm

The flat screen is fastened to a jointed arm.

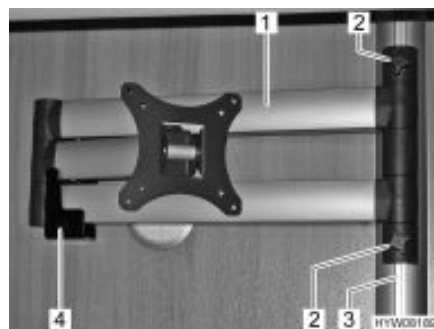

Fig. 7 Television (flat screen) on the jointed arm

Securing the flat screen in the holder:

- Swivel the flat screen into the initial position.
- Loosen knurled screws (Fig. 7,2).

- Move the jointed arm (Fig. 7,1) into the guide rail (Fig. 7,3) and place (Fig. 7) in the holder (Fig. 7,4).
- Re-tighten the knurled screws.

Flat screen in the TV compartment

The flat screen is attached to a console in the TV compartment of the individual seat.



Fig. 8 Television (flat screen) in the TV compartment

Storing the flat screen in the TV compartment:

- Return the flat screen into its initial position.
- Insert the holder for the flat screen until the latch (Fig. 8,1) locks into place.
- Close cover (Fig. 8,2).

3.6 Sink cover



- ▶ In the event of an accident or emergency braking, the sink cover (Fig. 9,1) could injure the occupants of the vehicle. Before the journey, take the sink cover off the sink and store it securely in the kitchen unit or wardrobe.



Fig. 9 Sink cover

3.7 Snow chains



- ▷ Only mount snow chains if there is a clearance of at least 50 mm between the tyres and the vehicle body.
- ▷ When using snow chains, the tyres, wheel suspension and steering are subjected to an additional load. When using snow chains, drive slowly (maximum speed 50 km/h) and only on streets which are completely covered with snow. Otherwise the vehicle could be damaged.
- ▷ Observe the fitting instructions issued by the manufacturer of the snow chains.
- ▷ Do not fit snow chains on alloy wheel rims.

The use of snow chains is subject to the legal regulations of the individual countries.

- Always mount snow chains to the drive wheels.
- After a few metres, check the tension of the snow chains.

3.8 Road safety



► Check tyre pressure before a journey or every 2 weeks. Wrong tyre pressure causes excessive wear and can lead to damage or even to tyre burst. You can lose control of the vehicle.

Before commencing the journey, work through the checklist:

Base vehicle

No.	Checks	Checked
1	All vehicle documents are on board	
2	Tyres in proper condition	
3	Vehicle lighting, brake lights and reversing lights function	
4	Oil levels for engine, gearbox and power steering controlled	
5	Coolant and fluid for windscreen washers filled up	
6	Brakes function	
7	Brakes react evenly	
8	When braking, the vehicle remains in the lane	

Housing body, outside

9	Awning completely retracted	
10	Roof free of snow and ice (in winter)	
11	External connections and lines disconnected and stored away	
12	External supports removed	
13	Fitted steady legs retracted and fixed in place	
14	Wheel chocks removed and stored away	
15	Entrance step retracted (observe warning tone)	
16	External flaps closed and locked	
17	Rear conversion door closed	
18	Overall height of the vehicle including roof rack when loaded measured and noted. Keep the height information close at hand in the driver's cabin	

Housing body, inside

19	Windows and skylights closed and locked	
20	Television securely stored	
21	Television antenna retracted (if one is built in)	
22	Loose parts stored away or fixed in position	
23	Open storage spaces empty	
24	No gas cartridges or other easily flammable materials stored in the roof cupboard of the awning light	
25	Sink cover is stored securely	
26	Refrigerator door secured	

No.	Checks	Checked
27	Refrigerator set to 12 V operation	
28	All drawers and flaps closed	
29	Living area doors and sliding doors secured	
30	Pull-down bed fixed to roof with retaining belt pulled tight	
31	Children's seats mounted to seats with three-point safety belts	
32	Swivel seat locking device for driver's seat and front passenger's seat locked	
33	Shades in the driver's cabin opened and secured	

Gas system

34	Gas bottles firmly fixed in the gas bottle compartment so that they are unable to turn	
35	Protective cap set on top of the gas bottle	
36	Regulator tap on the gas bottle and gas isolator taps are closed	

Electrical system

37	<p>Check the battery voltage of the starter and living area battery (see chapter 8). If the panel indicates that the battery voltage is too low, the respective battery will need to be recharged. Observe the notes and instructions in chapter 8</p> <p> ▷ Commence journey with fully charged starter and living area batteries.</p>	
----	--	--

Chapter overview

This chapter contains instructions on how to drive the motorhome.

The instructions address the following topics:

- driving speed
- the parking distance control
- curve light
- brakes
- seat belts
- child restraint system
- seats and headrests
- seating arrangement
- electrical window winders
- electrically adjustable external mirrors
- shades in the driver's cabin
- writing and reading rest
- bonnet
- windscreen washer fluid container
- checking the oil level
- filling the tank
- towing

4.1 Driving the motorhome



- ▶ The base vehicle is a commercial vehicle (small truck). Adjust your driving technique accordingly.
- ▶ Before commencing the journey and after short interruptions of the journey, ensure that the entrance step is completely retracted.
- ▶ During the journey, seat belts should always be worn at the seats that have seat belts mounted.
- ▶ Never open your seat belts when travelling.
- ▶ Passengers must remain in the seats provided.
- ▶ The doors must remain locked.
- ▶ Avoid braking with a jerk.
- ▶ If a navigation system is used, only change the destination when the vehicle is stationary. Drive to a car park or stop in a safe area when changing the destination.
- ▶ Do not play DVDs using the monitor of the navigation system during the journey.



- ▷ Drive slowly on poor roads.
- ▷ Take extreme care when driving onto ferries, crossing uneven roads and driving in reverse. Because of the relatively large overhang, larger vehicles might swing out and "touch ground" in unfavourable conditions. This can cause damage to the underbody or to parts fitted there.



- ▷ If an accident occurs as a result of these instructions not being observed, the manufacturer will not be responsible for damages caused.
- ▷ The safety measures stipulated in chapter 2 have to be observed.

4.2 Driving speed



- ▶ The vehicle is equipped with a powerful engine. This means there are sufficient reserves in difficult traffic situations. This high power enables a high maximum speed and requires above-average driving ability.
- ▶ The vehicle provides a large contact surface for wind. A sudden cross-wind can be especially dangerous.
- ▶ Uneven or one-sided loading affects road performance.
- ▶ Driving on unknown streets, you may encounter hazardous road conditions and unexpected driving situations. Therefore, in the interest of safety, make sure your driving speed is appropriate to any given driving situation and environment.
- ▶ Adhere to the national legal speed limits.

4.3 Parking distance control



- ▶ Be particularly careful when driving backwards. Risk of accident and injury.
- ▶ The parking distance control is only an auxiliary appliance and may not necessarily recognise all obstacles. The driver of the vehicle is responsible for safety. If the device fails or there is a malfunction and damage occurs, then claims cannot be asserted against the vehicle manufacturer.

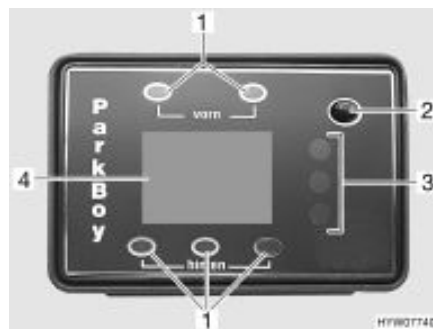

- 1 Position LED
- 2 On/Off key
- 3 Distance display
- 4 Display

Fig. 10 Parking distance control operating unit

Short description

The parking distance control serves as an aid for parking. The distance is measured by the ultrasonic echo sounder method. The distance is calculated during the runtime of a reflected ultrasonic signal.

In the passenger compartment, an operating unit with a display (Fig. 10) shows the distance to the obstacle. At the same time, an acute signal sounds as a warning.



- ▶ When you switch on the ignition, the parking distance control carries out the system check independently. During this, all LEDs and segments (bars on the display) light up briefly and a beep signal is heard. If, after the system check, the red LED of the distance display (Fig. 10,3) flashes and a fast repeating warning tone is heard, the system has recognised a sensor defect. The defective sensor is shown on the display (Fig. 10,4).

There are two ways to activate the parking distance control:

Activating by going into reverse gear:

- Switch on the ignition and start the engine.
- Go into reverse gear.
The display illuminates and an "ON" appears in the display. The parking distance control is ready to measure.

Activating by pressing the On/Off key on the operating unit:

- Press On/Off key (Fig. 10,2).
The display illuminates and an "ON" appears in the display. The parking distance control is ready to measure.

Switching off:

- The parking distance control can be switched off at all times independent of the selected switch-on method using the On/Off key (Fig. 10,2).

Distance display

The distance between the vehicle and the obstacle is issued in three ways:
The display (Fig. 10,4) shows the distance in steps of 5 cm. The lowest distance measured by a sensor is shown. What sensor delivers the measurement is shown by the illumination of the corresponding position LED (Fig. 10,1).
The three different-coloured LEDs (Fig. 10,3) are the second way of displaying. The change of the colours from green or yellow to red signalises that an obstacle is coming nearer.

In addition to the optical displays, an acoustic signal (sequence of tones) is issued, which changes in relation to the distance. If the distance between the vehicle and obstacle is reduced, the time intervals between the tone impulses also become shorter until it is a continuous tone.



- ▷ Further information can be obtained in the device manufacturer's instruction manual.

4.4 Curve light/fog light

Depending on the design, the vehicle is fitted with a curve light/fog light. The switch for the lights is located on the left of the dashboard.



Fig. 11 Switch for curve light/fog light

Switching on the lighting:

- Press the switch (Fig. 11,2). The green switch indicator lamp (Fig. 11,1) shows it is in operation.

4.5 Brakes



- ▶ Have defects on the braking system immediately remedied by an authorised specialist workshop.



- ▷ Avoid block brakings. Block braking gives the tyres "brake plates" of varying strength. This reduces driving comfort. It might even make the tyres unserviceable.

Before each journey

Before each journey, check by means of a braking test:

- Do the brakes function?
- Do the brakes react evenly?
- Does the vehicle remain in the lane when braking?

4.6 Seat belts

The vehicle is equipped with automatic three-point safety belts in the living area on the seats for which seat belts are compulsory by law. National regulations apply seat-belt fastening.



- ▶ Fasten your seat belts before the beginning of the journey and keep them fastened during the journey.
- ▶ Do not damage or trap belts. Have damaged seat belts changed by an authorised specialist workshop.
- ▶ Do not alter the belt fixing devices, automatic seat belt winders and the belt clips.
- ▶ Inspect the screwed connections of the seat belts from time to time in order to ensure that they are correctly seated.
- ▶ Only use one seat belt for **one** adult person.
- ▶ Do not belt in objects together with persons.
- ▶ Seat belts are not sufficient for persons who are less than 150 cm tall. In these cases use additional restraining devices. Observe test certificate.
- ▶ Factory-set three-point safety belts must be used when attaching child restraint systems.
- ▶ After an accident, replace the seat belts.
- ▶ During the journey, do not tilt the backrest too far backwards. Otherwise the functionality of the seat belt is no longer guaranteed.

4.6.1 Fastening the seat belt correctly



- ▶ Do not twist the belt. The belt must be positioned smoothly against the body.
- ▶ When fastening the seat belt, adopt the correct sitting position.

The seat belt is fastened correctly when a fist can be passed between the body and the seat belt.

4.7 Child restraint systems



- ▶ When travelling, secure children under 13 years of age that are smaller than 150 cm, with a suitable and officially approved child restraint system.
- ▶ Only attach the child restraint system to seats that are suitable for this purpose.
- ▶ Fasten the childrens' seat belts before commencing the journey and make sure that their seat belts are kept fastened during the journey.
- ▶ If a front passenger airbag is fitted in the vehicle, do not use a child restraint system (Reboard systems) that faces the back of the front passenger's seat. Follow warning notices in the vehicle.

Child restraint systems are divided into five classes:

Class	Body weight	Approximate age
0	Up to 10 kg	Up to 9 months
0+	Up to 13 kg	Up to 18 months
I	9 kg to 18 kg	9 months to 4 years
II	15 kg to 25 kg	3 years to 7 ½ years
III	22 kg to 36 kg	6 years to 12 years

The following illustrations show, which child restraint systems can be used on which seats.

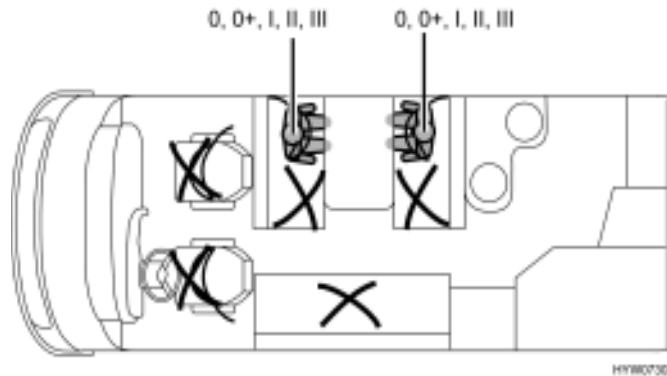

Fig. 12 Suitable seats for child restraint systems

4.8 Driver's seat and front passenger's seat



- ▶ Before commencing the journey, rotate all swivel seats in the direction of travel and lock in position.
- ▶ The seats must remain fixed in position during the journey and are not to be rotated.



Fig. 13 Seat adjustment

Rotating seat into driving position

The seats can be rotated in any direction. The seats can only be locked in position in the direction of travel.

- Push both armrests upward.
 - Push the seat backwards or into the central position.
 - Rotate the seat in the direction of travel and lock in position.
- ▷ Rotating the seats in the pitched vehicle is described in chapter 6.



Moving seat in lengthways direction

Adjust the driver's seat so that the driver can depress the pedals comfortably.

- Pull the bar (Fig. 13,2) upwards.
- Push the seat forwards or backwards.
- Release the bar. The seat must audibly lock into place.

Setting the seat inclination

Adjust the seat inclination so that the thighs rest on the seat surface without any pressure.

- Pull the lever (Fig. 13,3) upwards.
- Bring the seat into the desired inclination position by applying or relieving pressure.
- Release the lever. The seat must audibly lock into place.

Adjusting the backrest

Adjust the angle of the backrest so that the steering wheel can be held with the arms slightly bent.

- Turn the handle (Fig. 13,4).
- Bring the backrest into the desired inclination position by applying or relieving pressure.
- Release handle. The backrest must audibly lock into place.

Adjusting the armrest

The height of the armrests can be steplessly adjusted.

- For more convenient handling, first move the armrest slightly upward.
- Turn the knurled wheel (Fig. 13,1) for fine adjustments. The armrest inclines upwards or downwards, depending on the rotation direction.
- Swivel the armrest downwards and check the position.

4.9 Headrests



- ▷ The headrests are not adjustable for all models.



Fig. 14 Bench headrest

Before commencing the journey, adjust the headrest (Fig. 14,1) so that the back of the head is supported at approximately ear height. Push the headrest upwards or downwards by hand.

4.10 Seating arrangement



- ▶ During the journey, persons are only to sit on the permitted seats. The authorised number of seats is stipulated in the vehicle documents.
- ▶ During the journey sitting on the divans is not permitted.
- ▶ Seat belts must be worn by all passengers.



- ▷ More passengers may travel in the vehicle than specified in the vehicle documents if a seat is available for each person. The maximum permissible gross weight in a laden condition may however not be exceeded. The fluid containers may be emptied or the gas bottles may be removed to avoid exceeding the maximum permissible gross weight.

Seats which may be used during travel are equipped with a seat belt.

4.11 Electrical window winder



- ▶ Remove hands and other objects from the window before closing.
- ▶ Even if you leave your vehicle just briefly, remove the ignition key from the steering lock. Otherwise children may be able to operate the window winder and injure themselves.

There is an electrical window winder on the driver's side of the vehicle.



Fig. 15 Switch for the electrical window winder in the driver's door

Opening and closing: ■ Press switch (Fig. 15,1).

4.12 Electrically adjustable external mirrors

Depending on the model, the vehicle is equipped with two electrically adjustable and heated external mirrors. The switches for external mirror adjustment and the mirror heater are on the dashboard.

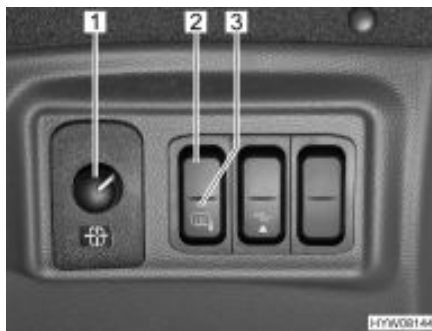

Fig. 16 Switches for electrically adjustable external mirrors

Adjusting: ■ Select the mirror to be adjusted. To do so, turn the rotary switch (Fig. 16,1) to the left or right.
 ■ Adjust the mirror by pressing the switch (Fig. 16,1) in the appropriate direction.

Switching on the heater: ■ Press the switch (Fig. 16,2). The red switch indicator lamp (Fig. 16,3) shows it is in operation.

4.13 Blind for windscreen



- ▶ While driving, the blind for the windscreen must be open and secured at the sides with both latches.

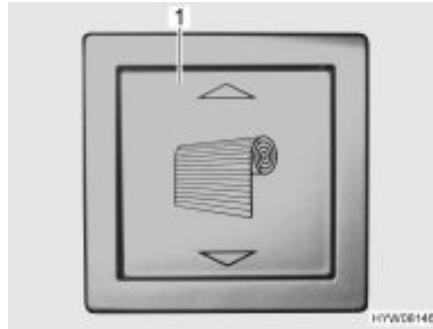

Fig. 17 Switch for blind

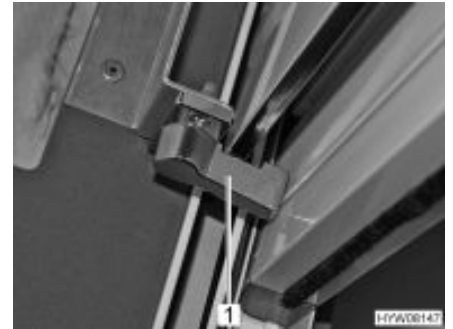

Fig. 18 Blind securing latch

The switch for operating the blind is installed next to the panel above the conversion door.

- Securing:*
- Push the button (Fig. 17,1) upwards and hold down until the blind has moved up completely.
 - Turn back the securing latch (Fig. 18,1) on both sides (Fig. 18).

4.14 Roman shades for driver's window and front passenger's window



- ▶ While travelling, the Roman shades for the driver's window and front passenger's window must be open, in a fixed position and secured.

- Securing:*
- Carefully push back the Roman shades for the side panes.
 - Secure the Roman shades with the retaining strap.

4.15 Writing and reading rest



- ▶ During the journey the writing and reading rest must be closed.



- ▷ If there is a passenger airbag, the writing and reading rest is locked so it cannot be opened.



Fig. 19 Writing and reading rest

4.16 Bonnet



- ▶ When the bonnet is open, there is a risk of injury in the engine compartment.
- ▶ Even if the engine was switched off some time ago, it might still be hot. Danger of burns!
- ▶ Do not work in the engine compartment while the engine is running.
- ▶ The bonnet must be kept firmly closed and locked during the journey. After closing, check whether the lock has engaged. In order to carry this out, pull on the bonnet.



Fig. 20 Release lever for the bonnet



Fig. 21 Bonnet

- Opening:*
- Pull the lever (Fig. 20, 1) situated on the left-hand side of the vehicle on the dashboard.
 - Place both hands on the top and the bottom edge of the bonnet (Fig. 21, 1).
 - Pull bonnet down towards you.
 - Swivel bonnet downwards.
- Closing:*
- Move the bonnet up. Slightly press back the bottom edge of the bonnet.
 - Press down bonnet at the bottom edge in the middle, until the spring-loaded catch engages audibly.
 - Check whether the bonnet is locked correctly. In order to do this, pull the bonnet forwards with force.

4.17 Filling with washer fluid



Fig. 22 Washer fluid container filler neck

- Unlock and open the bonnet.
- Remove the lid (Fig. 22, 1) from the filler neck of the washer fluid container.

- Slowly fill in washer fluid.
- Push the lid onto the filler neck of the washer fluid container.

4.18 Checking the oil level



- ▷ The oil dipstick is located behind the front crossbeam. The oil dipstick is marked in red.

4.19 Filling up with diesel



- ▶ No appliance operated by a naked flame (e.g. heater or refrigerator) may be in operation when filling the tank, on ferries or in the garage. Danger of explosion!
- ▶ The cap for the fuel filler neck and for the drinking water filler neck are very similar. Before filling the tank, always check the label.



- ▷ The fuel filler neck is labelled with the word "Diesel".

The fuel filler neck is situated on the exterior of the vehicle, at the front left.



Fig. 23 Cap for the fuel filler neck

- Opening:*
- Pull the flap (Fig. 23,1) upwards.
 - Insert the key in the locking cylinder (Fig. 23,2) and turn it in an anticlockwise direction.
 - Remove cap.
- Closing:*
- Place the cap on the fuel filler neck.
 - Turn key in a clockwise direction.
 - Remove the key.
 - Check that the cap is fastened securely on the fuel filler neck.
 - Close the flap and press it down.

4.20 Towing



- ▶ If the ignition key cannot be turned in the ignition lock, do not tow the vehicle. The steering will be locked.



- ▷ If the engine is not running or the power supply is disrupted, the servo assistance for the steering and brakes will not be operational. A considerable amount of force will be required for steering and braking. In this case only tow the vehicle with a towing bar.



- ▷ In addition observe the notes in the operating manual of the base vehicle.
- ▷ National regulations apply regarding fastening of seat belts.

If the vehicle has to be towed, it should be done on a transporter or trailer if at all possible. If this is not possible, we recommend always using a towing bar for towing. The towing bar must be approved for the weight of the vehicle.

Installing the towing eye

The holder for the towing eye is located behind a cover in the bumper on the right hand side.

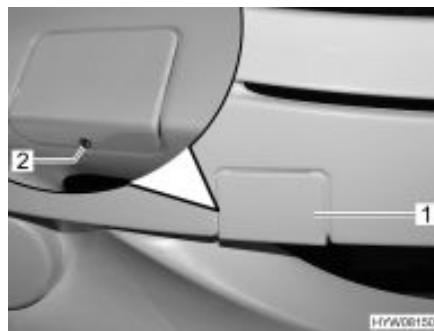

Fig. 24 Cover for the towing eye holder

- Undo the safety screw (Fig. 24,2) on the cover (Fig. 24,1).
- Remove the cover.
- Fit the towing eye in accordance with the instructions in the operating manual of the base vehicle.

Chapter overview

This chapter contains instructions on how to pitch the vehicle.

The instructions address the following topics:

- handbrake
- entrance step
- wheel chocks
- operation of the supports
- 240 V connection
- refrigerator
- retracting and extending the awning



- ▷ Pitch the vehicle so that it is as horizontal as possible. Secure the vehicle to prevent it from rolling.
- ▷ Animals (especially mice) can cause great damage to the interior of the vehicle. To prevent this from happening, regularly check the vehicle for damages or animal traces after pitching.

5.1 Handbrake

Firmly apply the handbrake when parking the vehicle.

5.2 Entrance step

In order to exit the vehicle, first fully extend the entrance step. If the entrance step is extended while the engine is still running, a warning tone will sound.

5.3 Wheel chocks

When parking the vehicle on slopes or inclines use the wheel chocks.

If the maximum permissible gross weight of the vehicle exceeds 4 tonnes, wheel chocks must be used when parking on gradients. The wheel chocks are provided as standard for vehicles with a maximum permissible gross weight exceeding 4 tonnes.

5.4 Supports

5.4.1 General instructions



- ▷ Do not use the fitted supports as a vehicle jack. They supports are only for stabilising the parked vehicle to prevent the rear axle from bottoming out.
- ▷ When pitching the vehicle, ensure that the supports are evenly loaded.
- ▷ Before driving away, wind up the supports as far as they can go, fully retract and secure them.



- ▷ When the ground is soft, place a pad or block under the supports in order to prevent the vehicle from sinking into the ground.
- ▷ Pitch the vehicle so that it is as horizontal as possible. Otherwise, the water from the shower tray will not be able to drain properly.

5.4.2 Steady legs



- ▷ Depending on the model, the hexagonal nut has a joint, which can be used to bring the attached socket spanner into a more convenient position for turning.

In order to ensure their correct function, clean and grease the interior tubes of the steady legs regularly.

The length of the steady legs can be adjusted according to the model.

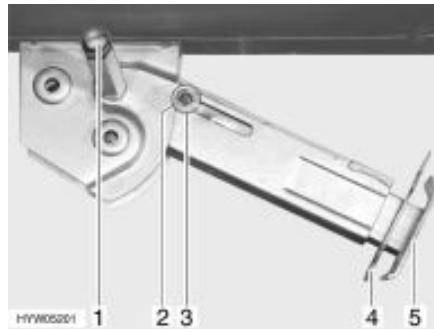

Fig. 25 Steady leg

- Extending:*
- Place the socket spanner on the hexagon nut (Fig. 25,1) and rotate until the steady leg is in a perpendicular downward position.
 - Remove the splint (Fig. 25,4) out of the support foot extension (Fig. 25,5).
 - Extend the support foot extension until it has reached the required length.
 - Insert the splint in the support foot extension.
 - Rotate the hexagonal nut until the steady leg rests completely on the ground and the vehicle is in a horizontal position.

- Retracting:*
- Place the socket spanner on the hexagon nut (Fig. 25,1) and rotate until the steady leg is clear of the ground.
 - Remove the splint (Fig. 25,4) out of the support foot extension (Fig. 25,5).
 - Push in the support foot extension (Fig. 25,5) and insert the splint (Fig. 25,4) in the drilled hole in the support foot extension.
 - Rotate the hexagonal nut (Fig. 25,1) with the socket spanner until the steady leg has swung upwards and the guide disc (Fig. 25,3) has completely retracted into the notch (Fig. 25,2).



- ▷ Before commencing the journey, observe the following: Are all steady legs and support foot extensions retracted completely and secured with the splint?

5.5 240 V connection

The vehicle can be connected to a 240 V power supply (see chapter 8).

5.6 Refrigerator

The 12 V operation of the refrigerator is only possible when the vehicle engine is running. When the vehicle engine is switched off, switch the refrigerator to 240 V operation or gas operation.

5.7 Awning



- ▷ When the support legs are not positioned, extend the awning a maximum of 1 m.
- ▷ Retract the awning in strong wind, rain or snow.
- ▷ In the case of light rain, shorten one of the support legs so that water can run off.
- ▷ Only retract the awning when the fabric is dry. When the awning must be retracted while the fabric is still wet: Extend the awning as soon as possible, in order to dry out the fabric.
- ▷ Before retracting, remove leaves and coarse dirt from the awning.

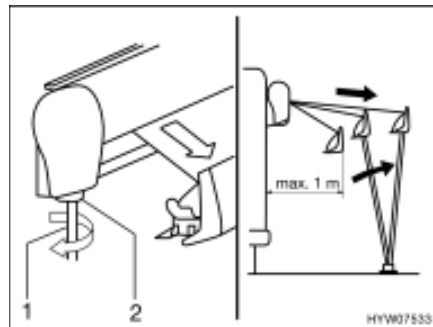

Fig. 26 Extend awning

- Insert the crank (Fig. 26,1) in the bayonet socket (Fig. 26,2) of the awning and turn in an anticlockwise direction. The awning begins to extend after a few rotations.
- Continue turning the crank until the awning is extended approx. 1 m.

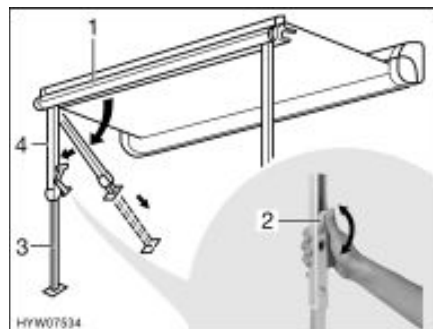

Fig. 27 Position support legs

- Fold out the support legs (Fig. 27,4) from the front bar (Fig. 27,1) and position them.
- Open the lock on the support legs. To do this, turn the catch lever (Fig. 27,2) upwards.
- Pull out the lower parts of the support legs (Fig. 27,3) until they reach the desired length.
- Close the lock on the support legs. To do this, turn the catch lever downward once again.
- Use the crank to completely extend the awning.
- Turn the crank slightly in a clockwise direction to tighten the fabric.
- Set the support legs to their final height.

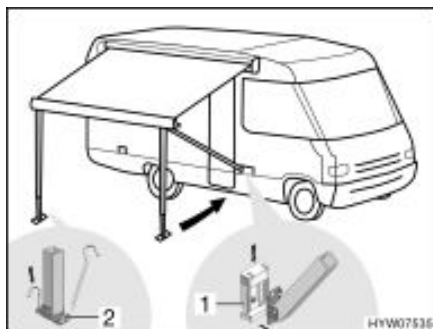

Fig. 28 Fasten support legs

- Clamp the support legs in the brackets (Fig. 28,1) on the vehicle or fasten to the ground using tent pegs (Fig. 28,2).



- ▷ Further information can be obtained from the separate instruction manual for the awning.

Chapter overview

This chapter contains instructions about living in the vehicle.

The instructions address the following topics:

- opening and closing the doors and external flaps
- ventilation of the vehicle
- opening and closing the windows and blinds
- opening and closing the shades in the driver's cabin
- opening and closing the skylights
- rotating the seats
- modifying the table surfaces
- positioning the television
- use of the beds

6.1 Doors



▶ Only drive with locked doors.



- ▷ Locking the doors can prevent them from opening of their own accord, e.g. during an accident.
- ▷ Locked doors also prevent forced entry, e.g. when waiting at traffic lights. However, in an emergency, locked doors make it more difficult for helpers to enter the vehicle.
- ▷ When leaving the vehicle, always lock the doors.

6.1.1 Conversion door, outside

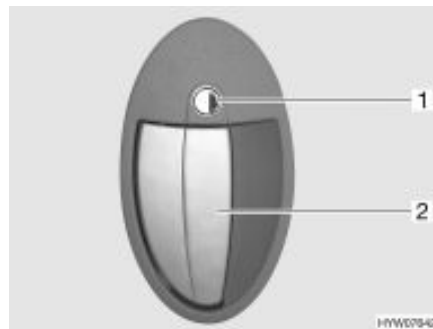

Fig. 29 Door lock, outside

- Opening:*
- Insert the key in the locking cylinder (Fig. 29,1) and turn it in a clockwise direction until the door lock is unlatched.
 - Return the key to the central position and remove it.
 - Pull on the handle (Fig. 29,2). The door is open.
- Locking:*
- Insert the key in the locking cylinder (Fig. 29,1) and turn it in an anticlockwise direction until the door lock is engaged.
 - Return the key to the central position and remove it.

6.1.2 Conversion door, inside



Fig. 30 Door lock, inside

- Opening:*
- Push the handle (Fig. 30,1) down.
- Locking:*
- Turn the handle (Fig. 30,1) approx. 45° upward and leave it in this position.

6.1.3 Driver's door, outside



Fig. 31 Door lock of driver's door, outside

- Opening:*
- Insert the key into locking cylinder (Fig. 31,2) and turn until the door lock is unlatched.
 - Return the key to the central position and remove it.
 - Pull on the handle (Fig. 31,1). The door is open.
- Locking:*
- Insert the key into locking cylinder (Fig. 31,2) and turn until the door lock is engaged.
 - Return the key to the central position and remove it.

6.1.4 Driver's door, inside

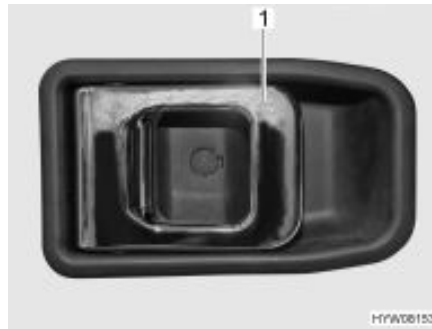

Fig. 32 Door lock of driver's door, inside

Opening: ■ Pull on the handle (Fig. 32,1). The door lock is unlatched. The safety knob automatically jumps out.

Locking: ■ Push the safety knob in.

6.1.5 Insect screen on the conversion door, extendable



▷ Open the insect screen completely before closing the conversion door.



Fig. 33 Insect screen

Closing: ■ Pull out the insect screen completely by the bar (Fig. 33,1).

Opening: ■ Push the insect screen into its initial position by the bar (Fig. 33,1).

6.2 External flaps



- ▷ Before commencing the journey, close all external flaps and lock them.
- ▷ To open and close the external flap, open or close all locks that are fitted to the external flap.



▷ When leaving the vehicle, close all external flaps.

The external flaps fitted to the vehicle are all fitted with identical locking cylinders. Therefore, all locks can be opened with a single key.

6.2.1 Flap lock, elliptical-shaped



- ▷ During rain, water can penetrate the opened flap lock. Therefore close the lock handle.

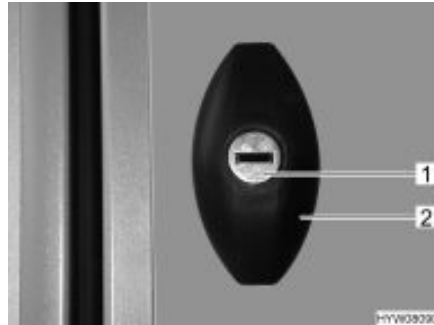

Fig. 34 Flap lock, elliptical-shaped, closed

- Opening:*
- Insert key into locking cylinder (Fig. 34,1) and turn one half turn in an anticlockwise direction. The lock handle (Fig. 34,2) snaps out.
 - Remove the key.
 - Turn lock handle one half turn in an anticlockwise direction. The flap lock is open.
- Closing:*
- Firmly close the external flap.
 - Give the lock handle one half turn in a clockwise direction. The flap lock is now engaged but not locked.
 - Insert key into locking cylinder.
 - Press down lock handle with key inserted and turn key one half turn in a clockwise direction. The lock handle will stay bolted.
 - Remove the key.

6.2.2 Underfloor sliding drawer



- ▷ The maximum permitted underfloor sliding drawer load is 40 kg.



Fig. 35 Retainer on the underfloor sliding drawer

Opening:

- Open the flap lock (Fig. 35,1) as described above.
- Push the retainer (Fig. 35,2) down, keep it pressed and pull out the under-floor sliding drawer.

6.3 Ventilation



▶ The oxygen in the vehicle interior is used up by breathing and the use of gas operated appliances. That is why the oxygen needs to be replaced on a constant basis. For this purpose, forced ventilation options (e.g. skylights with forced ventilation, mushroom-shaped vents or floor vents) are fitted to the vehicle. Never cover or block forced ventilations from the inside or outside with objects such as e.g. a winter mat. Keep forced ventilations clear of snow and leaves. There is a danger of suffocation due to increased CO₂ levels.



- ▷ Although sufficient ventilation is provided, in certain weather conditions, condensation can form on metal objects (e.g. screwed connections in the floor).
- ▷ Additional cold spots can occur at thermal "bridges" (e.g. mushroom-shaped vents, skylight edges, sockets, filler necks, flaps, etc.).

Condensation

Ensure that there is a continuous exchange of air by providing frequent and efficient ventilation. This is the only method for ensuring that condensation and resulting mould is not formed during cool weather. During the colder season, a pleasant living climate is created if heating output, air distribution and ventilation are synchronised. To avoid draft close the air outlet nozzles on the dashboard and set the air distribution of the base vehicle to air circulation.

If the vehicle is laid up for a longer period, occasionally ventilate it well, especially in summer as heat accumulation can occur. Do not only air the interior, but also the storage compartments which are accessible from the outside. Air the parking place as well if the vehicle is parked in a closed space (e.g. garage). The occurrence of condensation could lead to the formation of mould.

6.4 Windows



- ▷ The windows are fitted with a blind or Roman shade and with an insect screen or folding insect screen. After the latch has been released, the blind and insect screen automatically spring back to the initial position by tensile force. In order not to damage the tension mechanics, hold onto the blind or insect screen and allow it to slowly return to the initial position. The Roman shade and folding insect screen are made of thin woven fabric. In order not to damage the Roman shade or the insect screen, grasp the respective handle and carefully return it to the initial position.
- ▷ Do not keep blinds closed over a longer period of time as that can cause increased material wear.
- ▷ If the blind or the Roman shade is completely closed, exposure to direct sunlight can cause heat to accumulate between the blind/the Roman shade and the window. The window could be damaged.
Therefore, if the shade is installed in the bottom blind box, close the shade only 2/3 when sunlight is intense. This allows the heat to escape between the window and the shade.
If the shade is installed in the top blind box, close the shade fully and open it regularly.
Also move the window into the "continuous ventilation" position.
- ▷ Before commencing the journey, close the windows.
- ▷ Depending on the weather, close the windows far enough to prevent moisture from entering.



- ▷ When leaving the vehicle, always close the windows.
- ▷ In extreme weather conditions or if the temperature fluctuates strongly, a light condensation film can form on the double-glazed acrylic glass. The glass is designed in such a way that condensation can evaporate when the external temperature increases. There is no danger of the double-glazed acrylic glass being damaged by condensation.
- ▷ The upholstery will fade over time, if it is exposed to sunlight. If the temperature within the vehicle rises rapidly as well, the colour will change at an accelerated rate.
Therefore, we recommend to close the shades on the windows when there is strong sunlight. Ensure that heat does not build up when you close the blind.

6.4.1 Sliding window without lock



Fig. 36 Sliding window without lock

- Opening:*
- Unfold the handle (Fig. 36,1).
 - Push or pull forward the window section into the required position.
- Closing:*
- Close the window as far as possible and let the handle lock in place.

6.4.2 Hinged window with automatic hinges



- ▷ Open the window completely, to release the lock. If the locking device is not released and the window is closed nevertheless, there is the danger of the window breaking due to the massive counter-pressure.
- ▷ When opening the hinged windows, ensure that there are no torsional forces. Open and close the hinged windows evenly.
- ▷ The catch lever is fitted with a safety knob. When operating the catch lever, always press the safety knob.

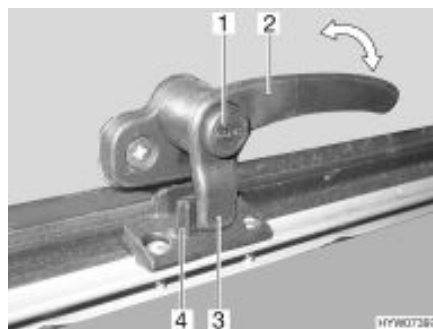

Fig. 37 Catch lever in "closed" position



Fig. 38 Hinged window with automatic hinges

- Opening:*
- Press the safety knob (Fig. 37,1) and keep it pressed.
 - Turn the catch lever (Fig. 37,2) a quarter turn towards the centre of the window.
 - Open the hinged window to the desired latched position. The automatic hinge (Fig. 38,1) locks in place automatically.

The hinged window remains locked in the required position.

- Closing:*
- Open the hinged window as wide as is necessary to release the lock.
 - Close the hinged window.

- Press the safety knob (Fig. 37,1) and keep it pressed.
- Turn the catch lever (Fig. 37,2) a quarter turn towards the window frame. The locking catch (Fig. 37,3) on the catch lever is entirely on the inner side of the window catch (Fig. 37,4).

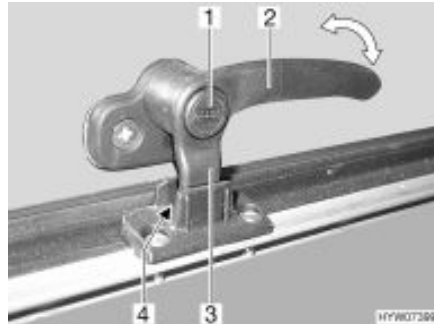

Fig. 39 Catch lever in the "continuous ventilation" position

Continuous ventilation

With the catch lever, the hinged window can be placed in two positions:

- "Continuous ventilation" (Fig. 39)
- "Firmly closed" (Fig. 37)

To place the hinged window into the "continuous ventilation" position:

- Press the safety knob (Fig. 39,1) and keep it pressed.
- Turn the catch lever (Fig. 39,3) a quarter turn towards the centre of the window.
- Lightly open the hinged window outwards.
- Return the catch lever to its initial position. Move the locking catch (Fig. 39,3) on the catch lever into the recess of the window catch (Fig. 39,4).
- Release the safety knob (Fig. 39,1).
- Make certain that the safety knob is not pushed in but rather that it secures the catch lever.

During the journey, the hinged window may not be in "continuous ventilation" position.

If it rains, the "continuous ventilation" hinged window position could lead to splashing water penetrating the living area. Therefore, close the hinged windows completely.

6.4.3 Hinged sunroof with automatic hinges



- ▷ Open the window completely, to release the lock. If the locking device is not released and the window is closed nevertheless, there is the danger of the window breaking due to the massive counter-pressure.
- ▷ When opening the hinged windows, ensure that there are no torsional forces. Open and close the hinged windows evenly.
- ▷ Do not open the hinged window if there is a risk of frost. The hinge rail could be damaged.

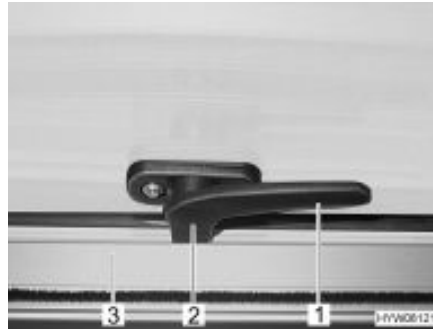

Fig. 40 Catch lever in "closed" position

- Opening:*
- Turn the catch lever (Fig. 40,1) a quarter turn towards the centre of the window.
 - Open the hinged window to the desired latched position. The automatic hinge automatically locks in place.

The hinged window remains locked in the required position.

- Closing:*
- Open the hinged window as wide as is necessary to release the lock.
 - Close the hinged window.
 - Turn the catch lever (Fig. 40,1) a quarter turn towards the window frame. The locking catch (Fig. 40,2) is located on the inside of the window catch (Fig. 40,3).

6.4.4 Roman shade and insect screen

The windows are fitted with a Roman shade and an insect screen. The insect screen can only be operated together with the Roman shade.



Fig. 41 Hinged window

Roman shade The Roman shade is located in the bottom blind box.

- Closing:*
- Grasp the Roman shade (Fig. 41,2) using the holding bar, pull it upwards and then release it at the desired height. The Roman shade will stay at this height.

- Opening:*
- Grip the Roman shade in the middle of the holding bar and push it down.

Insect screen The insect screen is located in the upper blind box.

- Closing:*
- Pull the insect screen downwards using the handle (Fig. 41,1) until it pushes against the Roman shade (Fig. 41,2).
 - Lock the insect screen in position with the Roman shade.

- Opening:*
- Press the handle (Fig. 41,1) attached to the insect screen.
 - Use handle to return the insect screen slowly to its initial position.

6.4.5 Roman shade and insect screen (hinged sunroof)

The hinged sunroof is fitted with a Roman shade and insect screen.

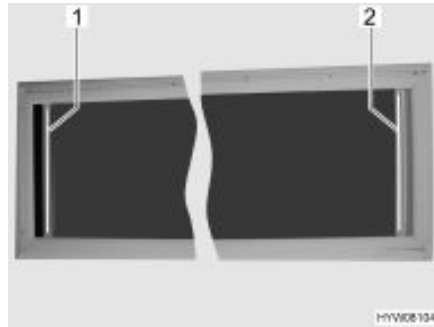

Fig. 42 Hinged sunroof

Roman shade The Roman shade can be operated separately from the insect screen.

- Closing:*
- Grip the Roman shade (Fig. 42,2) in the centre of the holding bar, pull it out and release it at the required position. The Roman shade will stay in that position.

- Opening:*
- Grip the Roman shade (Fig. 42,2) in the centre of the holding bar and slowly push it to its initial position.

Insect screen The insect screen can be used separately from the Roman shade and can also stay fully closed if required.

- Closing:*
- Grip the insect screen in the centre of the holding bar (Fig. 42,1), pull it out and release it at the required position. The insect screen will stay in that position.

- Opening:*
- Grip the insect screen in the centre of the holding bar and slowly push it to its initial position.

6.4.6 Blind for windscreen

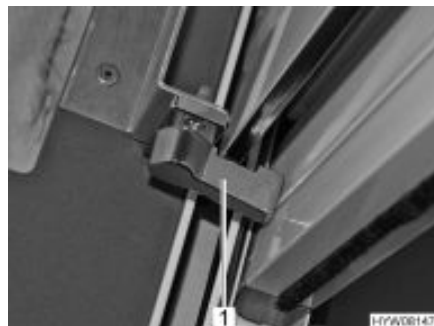

Fig. 43 Blind securing latch

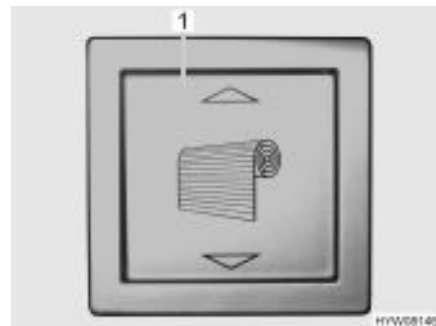

Fig. 44 Switch for blind

The switch for operating the blind is installed next to the panel above the conversion door.

- Closing:*
- Turn forward the securing latch (Fig. 43,1) on both sides.
 - Push and hold the button (Fig. 44,1) down until the blind has reached the required position.
 - Release the button. The blind will stay in that position.
- Opening:*
- Push the button (Fig. 44,1) upwards and hold down until the blind has moved up completely.
 - Release the button.
 - Turn back the securing latch (Fig. 43,1) on both sides (Fig. 43).

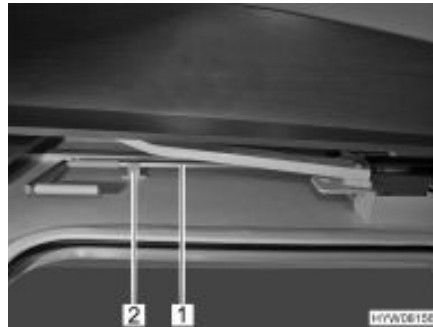

Fig. 45 Hand crank for emergency operation (secured)

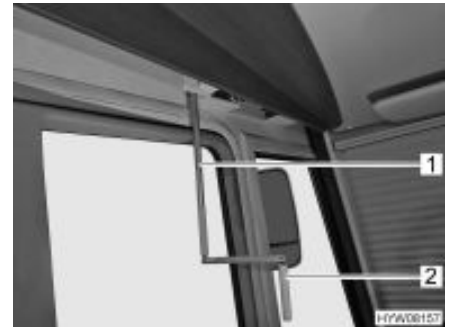

Fig. 46 Hand crank for emergency operation (ready to operate)

Emergency operation

If the blind can no longer be operated using the switch (for example, due to a loss of the vehicle's power supply), the blind can be operated manually. To do this, proceed as follows:

- Pull the hand crank (Fig. 45,1) out of the holder (Fig. 45,2) above the driver's door and fold it down.
- Fold over the end piece (Fig. 46,2) of the hand crank (Fig. 46,1) by 180° (Fig. 46).
- Open or close the blind with the hand crank manually.
- Press the hand crank into the holder again (Fig. 45,2).

6.4.7 Roman shades for driver's window and front passenger's window

- Closing:*
- Release the retaining strap for the Roman shade.
 - Close the Roman shade carefully until the magnet catch keeps the Roman shades closed.
- Opening:*
- Pull or push back the Roman shades carefully.
 - Secure the Roman shade with the retaining strap.

6.5 Skylights

Depending on the model, skylights with or without forced ventilation are fitted to the vehicle. If a skylight is fitted without forced ventilation, the forced ventilation is performed using mushroom-shaped vents.



► The apertures for forced ventilation must always be kept open. Never cover or block forced ventilations with objects such as e.g. a winter mat. Keep forced ventilations clear of snow and leaves.



- ▷ The skylights are fitted with a blind or Roman shade and an insect screen. After the latch has been released, the blind and insect screen automatically spring back to the initial position by tensile force. In order not to damage the tension mechanics, hold onto the blind or insect screen and allow it to slowly return to the initial position.
- ▷ Do not keep blinds closed over a longer period of time as that can cause increased material wear.
- ▷ If the blind or the Roman shade is completely closed, exposure to direct sunlight can cause heat to accumulate between the blind/the Roman shade and the skylight. The skylight could be damaged. For that reason, close the blind/Roman shade only 2/3 of the way in direct sunlight. Open the skylight slightly or move it to ventilation position.
- ▷ Depending on the weather, close the skylights far enough to prevent moisture from entering.
- ▷ Do not climb on the skylights.
- ▷ Before commencing the journey, close the skylights.
- ▷ Before commencing the journey, check that the skylights are closed and locked.



- ▷ When leaving the vehicle, always close the skylights.
- ▷ The upholstery will fade over time, if it is exposed to sunlight. If the temperature within the vehicle rises rapidly as well, the colour will change at an accelerated rate.
Therefore, we recommend closing the shades on the skylights of the parked vehicle by 2/3 when there is strong sunlight.

6.5.1 Hinged skylight

The hinged skylight may be opened on one side only. Three inclination angles and a ventilation position are available.

An extension hook is included as standard equipment.

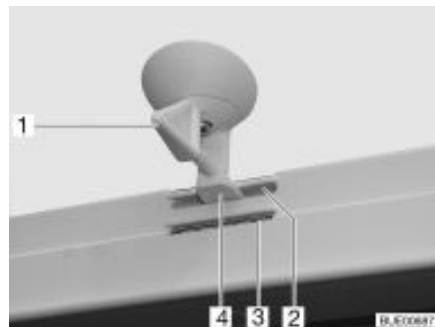

Fig. 47 Hinged skylight, lock

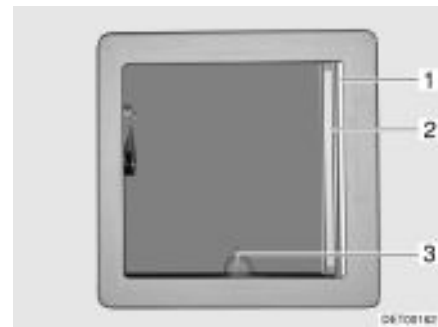

Fig. 48 Hinged skylight

Opening:

- Turn the lever (Fig. 47,1 or Fig. 48,3) one quarter turn.
- Grip lever and push hinged skylight upwards.

Closing:

- Grip lever and pull hinged skylight downwards.
- Turn the lever one quarter turn. The latch (Fig. 47,4) must slide into the lower aperture (Fig. 47,3).

Locking in the ventilation position:



- Grip lever and pull hinged skylight downwards.
- Turn the lever one quarter turn. The latch (Fig. 47,4) must slide into the upper aperture (Fig. 47,2).
- ▷ If it rains and the hinged skylight is in ventilation position, that could lead to water penetrating the living area. Therefore close hinged skylight completely.

Roman shade

The Roman shade may be closed at any position, either with the hinged skylight open or closed.

Closing:

- Pull out Roman shade (Fig. 48,1) and release in the required position. The Roman shade will stay in that position.

Opening:

- Slowly push the Roman shade at the handle to its initial position.

Insect screen



- ▷ The insect screen may be damaged if it is closed with the hinged skylight closed. Therefore only close the insect screen when the hinged skylight is open.

Closing:

- Pull insect screen (Fig. 48,2) out until it engages with the latch on the opposite side.

Opening:

- Slightly push up insect screen along the strip. Latch is released.
- Slowly return insect screen into its initial position.

6.5.2 Wind-up skylight

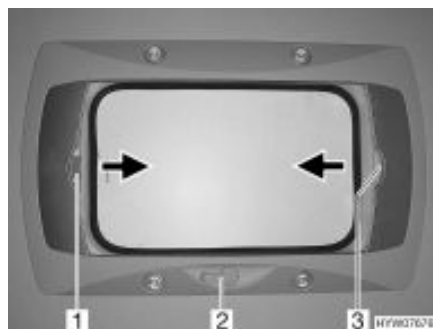

Fig. 49 Wind-up skylight

The wind-up skylight can be opened using the manual crank.

Opening:

- Rotate the hand crank (Fig. 49,2) until a resistance can be felt (max. opening angle 70°).

Closing:

- Rotate the hand crank until the wind-up skylight is closed. The wind-up skylight can be locked after rotating two or three more times.
- Check the locking mechanism. To do so, press your hand against the acrylic glass.

Roman shade

The Roman shade can be closed in any position, as desired. If the Roman shade is locked with the insect screen, the insect screen is also moved along on closing the Roman shade.

Closing: ■ Pull the handle of the Roman shade (Fig. 49,3) in the direction of the arrow and release it in the desired position. The Roman shade will stay in that position.

Opening: ■ Slowly push the Roman shade at the handle to its initial position.

Insect screen If the insect screen is locked with the Roman shade, the Roman shade is also moved along on closing the insect screen.

Closing: ■ Use the handle to pull the insect screen (Fig. 49,1) in the direction of the arrow to the opposite handle of the Roman shade (Fig. 49,3) and allow it to engage.

Opening: ■ Press the handle of the insect screen (Fig. 49,1) at the back upwards and detach the insect screen from the Roman shade (Fig. 49,3).
■ Use handle to return the insect screen slowly to its initial position.

6.6 Rotating seats



▶ Before commencing the journey, rotate all swivel seats in the direction of travel and lock in position. During the journey, the swivel seats must remain locked in place in the direction of travel.



▷ Setting the position of the seats and armrests is described in chapter 4.

The lever for rotating the seat is located at the side of the seat.



Fig. 50 Lever, side

Turning: ■ Push both armrests at the driver's/front passenger's seat upward.
■ Push the driver's seat/front passenger's seat backwards or into the central position.
■ Pull the lever (Fig. 50,1) to turn the seat forwards. The seat is released from the locking device.

The seats can be rotated in any direction. The seats can only be locked in position in the direction of travel.

6.7 Fixed table with rigid table leg

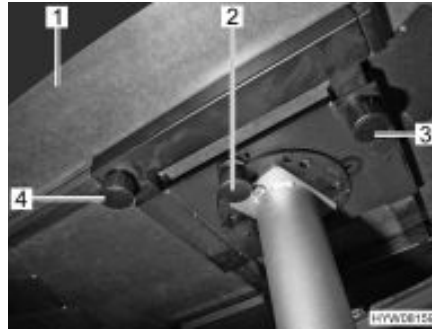

Fig. 51 Fixed table with rigid table leg

The table-top of the fixed table of the rigid table leg can be moved both lengthways and crossways. In addition, the table top can be rotated. It is not possible to convert it into a bed foundation.

Moving in a lengthways direction:

- Loosen knurled screw (Fig. 51,4).
- Move table-top (Fig. 51,1) to the desired position.
- Re-tighten the knurled screw.

Moving in a crossways direction:

- Loosen knurled screw (Fig. 51,3).
- Move table-top (Fig. 51,1) to the desired position.
- Re-tighten the knurled screw.

Turning:

- Pull down the knob (Fig. 51,2) on the lock.
- Turn table-top (Fig. 51,1) to the required position.
- Turn the table-top to and fro slightly until the lock engages.

6.8 TV unit



- ▶ Before commencing the journey, store the television securely.
- ▶ Before commencing the journey, turn the flat screen and the screen holder back to the basic position, push them in and secure them.

6.8.1 Positioning the flat screen

Flat screen in the TV cabinet

The flat screen is attached to a console in the TV cabinet.



Fig. 52 Flat screen in the TV cabinet

- Pull the release lever/handle (Fig. 52,1) forwards.
- Use handle to pull out as far as possible.
- Swivel flat screen into the desired position.

Flat screen on jointed arm

The flat screen is fastened to a jointed arm.

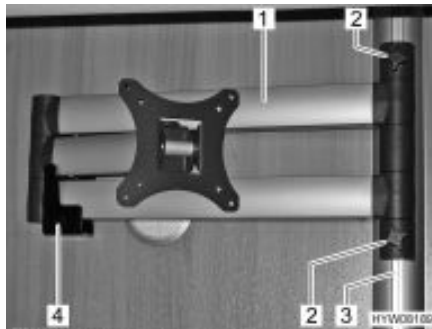

Fig. 53 Flat screen on jointed arm

- Loosen knurled screws (Fig. 53,2).
- Move the jointed arm (Fig. 53,1) upwards into the guide rails (Fig. 53,3) until the jointed arm is no longer held by the holder (Fig. 53,4).
- Move the flat screen to the required height and swivel it into required position.
- Re-tighten the knurled screws (Fig. 53,2).
- Take hold of the flat screen at the top and bottom edge with both hands and set the desired angle of inclination.

Flat screen in the TV compartment

The flat screen is attached to a console in the TV compartment of the individual seat.



Fig. 54 Flat screen in the TV compartment

- Open cover (Fig. 54,1).
- Lightly press the lifting mechanism (Fig. 54,2) downwards to release the spring.
- Pull the release knob (Fig. 54,3). The flat screen (Fig. 54,4) automatically moves upwards a little.
- Take hold of the flat screen at the left and right of the housing and pull it upwards to the stop.
- Swivel flat screen into the desired position.

6.8.2 Equipment with automatic antenna alignment



▶ Before commencing the journey, ensure that the antenna is in park position. Danger of accidents!



- ▷ The vehicle must be still during the satellite search. Do not walk through the vehicle.
- ▷ Satellite reception is only possible, when the antenna is positioned in direct line of sight of the chosen satellite and the view is not blocked in any way.
- ▷ Also read the manufacturer's instruction manual.

The satellite unit is equipped with an automatic positioning unit. This automatic positioning unit ensures that the antennas are precisely aligned to the desired satellites.

Operation is menu-controlled (TV screen) using the remote control.

Setting up the unit:

- Switch on the television.
- Use the mains switch to switch on the receiver. When the green LED on the receiver's infra-red receptor lights up, the receiver is ready to operate.
- Switch on the receiver with the remote control. The satellite antenna repositions itself out of the park position and into search mode.

When the system finds the satellite, the selected TV programme appears automatically.

6.9 Beds

6.9.1 Pull-down bed



- ▶ The maximum permitted pull-down bed load is 200 kg.
- ▶ The pull-down bed is not to be used for the storage of luggage. When the bed is not being used, only place the bed linen (max. 8 kg) which is required for two persons in it.
- ▶ Before commencing the journey, secure the pull-down bed to the roof using the retaining belt. Tighten the retaining belt firmly.
- ▶ Only use the pull-down bed, if the safety net is set up.
- ▶ Never allow small children to remain in the pull-down bed without supervision.
- ▶ But in particular with regard to small children less than 6 years of age, users should ensure that they cannot fall out of the pull-down bed.
- ▶ Use separate children's beds or travel cots suitable for children.
- ▶ Switch off the reading lamps in the pull-down bed before the bed is pushed up. Fire hazard!
- ▶ Switch off the reading lamps on the underside of the pull-down bed when the bed is lowered. Fire hazard!



- ▷ Do not use the armrest on the driver's seat to help get into bed.

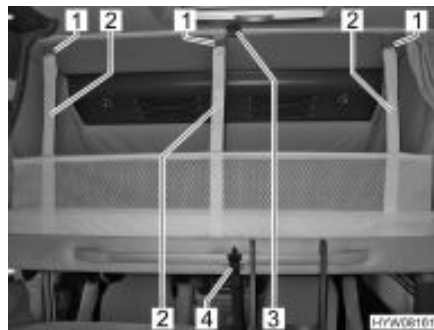

Fig. 55 Pull-down bed complete with applied safety net

Opening the pull-down bed:

- Rotate the driver's and front passenger's seats in the direction of travel, lock in position, push forwards and fold the backrest as far forward as possible.
- Close the shade in the driver's cabin.
- Release the retaining belt (Fig. 55,4).
- Pull the pull-down bed down with both hands in an arch.

Closing the pull-down bed:

- Switch off the reading lamps on the ceiling.
- Release retaining belts (Fig. 55,2) and place safety net underneath mattress.
- Use both hands to push pull-down bed upwards.
- Secure the pull-down bed on the roof (Fig. 55,3) by means of the retaining belt (Fig. 55,4).

Safety net The safety net and the retaining belts are located underneath the mattress in the pull-down bed. Only use the safety net if persons are already in the pull-down bed.

Setting up: ■ Attach the retaining belts (Fig. 55,2) to the hooks (Fig. 55,1) on the ceiling.

Access ladder Depending on the model, only get in the pull-down bed using the access ladder supplied or the divan.

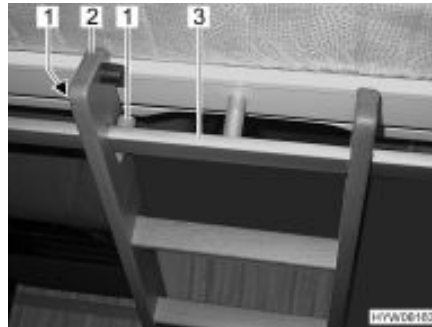

Fig. 56 Access ladder, hooked in

Attaching: ■ Hook the access ladder (Fig. 56,2) to the pull-down bed by attaching the two hooks in the holding bar (Fig. 56,3). When attaching, ensure that the ladder rung is positioned between the two fixtures (Fig. 56,1). This prevents lateral movement of the access ladder.

Storing away: ■ Hang the access ladder (Fig. 56,2) from the holding bar (Fig. 56,3) on the pull-down bed.
 ■ Store the access ladder securely.

6.9.2 Pull-down bed, electrically operated



- ▶ Switch off the reading lamps in the pull-down bed before the bed is pushed up. Fire hazard!
- ▶ Switch off the reading lamps on the underside of the pull-down bed when the bed is lowered. Fire hazard!
- ▶ The maximum permitted pull-down bed load is 200 kg.
- ▶ Before commencing the journey, secure the pull-down bed to the roof using the retaining belt. Tighten the retaining belt firmly.
- ▶ Only use the pull-down bed, if the safety net is set up.
- ▶ The pull-down bed is not to be used for the storage of luggage. When the bed is not being used, only place the bed linen (max. 8 kg) which is required for two persons in it.
- ▶ Do not allow children to play with the pull-down bed.
- ▶ Never allow small children to remain in the pull-down bed without supervision.
- ▶ But in particular with regard to small children less than 6 years of age, users should ensure that they cannot fall out of the pull-down bed.
- ▶ Use separate children's beds or travel cots suitable for children.
- ▶ Do not reach into the area between the bed and the side wall when lowering or raising. Danger of bruises!



- ▶ Only lower or raise the bed when there is nobody on it or there are no loads on it.
- ▶ Only lower the bed if the lowering area is clear.
- ▶ Always lower the bed until it rests on the side supports.



- ▷ Do not use the armrest on the driver's seat to help get into bed.



Fig. 57 Control unit

Making ready for operation

After every power interruption (e.g. lay-up over winter), the electrical drive must be made ready for operation again. To do this, proceed as follows:

- On the control unit (Fig. 57,3) press both arrow keys (Fig. 57,1 and 2) simultaneously and keep them pressed until the pull-down bed has moved fully down. Once the button is released, a beep sounds to confirm.

Opening the pull-down bed:

- On the control unit (Fig. 57,3), press the bottom arrow key (Fig. 57,2) and keep it pressed until the pull-down bed has moved down into its end position.



- ▷ When closing the pull-down bed, pull the side fabric panels inwards. This prevents the fabric from getting trapped in the lock of the pull-down bed.

Closing the pull-down bed:

- On the control unit (Fig. 57,3), press the top arrow key (Fig. 57,1) and keep it pressed until the pull-down bed has moved up into its end position.
- Secure pull-down bed to the roof by means of the retaining belt.

Overload protection

If the pull-down bed meets an obstacle during opening or closing (e.g. a person or a headrest), the overload protection stops the movement.

- Use the arrow keys (Fig. 57,1 or 2) to move the pull-down bed in the opposite direction.
- Use the arrow keys to move the pull-down bed in the required direction.

Faults

If an error occurs while opening or closing (e.g. motor fault or power failure) the movement stops.

- Rectify the fault (or have it rectified).
- Make ready for operation.

If the living area battery is flat or the transformer/rectifier has switched off the power supply due to undervoltage (battery monitor), then the pull-down bed can no longer be opened or closed.

- Switch off all appliances.
- Start the vehicle engine.
- If necessary, switch the 12 V power supply on.
- Open or close the pull-down bed.

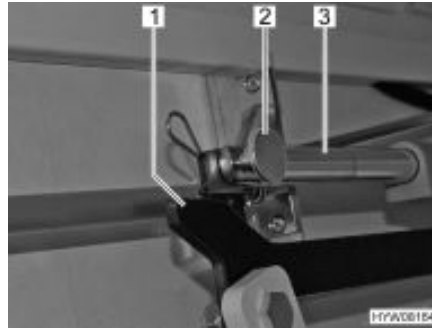

Fig. 58 Drive

Emergency operation

If the pull-down bed can no longer be moved via the control unit (e.g. due to loss of the vehicle's power supply), it can also be operated manually. To do this, proceed as follows:

- Remove side fabric panels.
- Remove the connection (e.g. securing splint and pin) (Fig. 58,2) between the push rod (Fig. 58,3) and lever (Fig. 58,1).
- Remove the push rod.
- Open or close the pull-down bed manually.
- Contact customer service.

Chapter overview

This chapter contains instructions regarding the gas system of the vehicle. The instructions address the following topics:

- safety
- changing the gas bottles
- gas isolator taps
- external gas connection
- automatic switching facility

The operation of the gas operation appliances of the vehicle is described in chapter 9.

7.1 General



- ▶ Before commencing the journey, when leaving the vehicle or when gas equipment is not in use, close all gas isolator taps and the main isolator tap on the gas bottle.
- ▶ No appliance operated by a naked flame (e.g. heater or refrigerator) may be in operation when filling the tank, on ferries or in the garage. Danger of explosion!
- ▶ Do not use appliances operated with a naked flame in closed spaces (e.g. garages). Danger of poisoning and suffocation!
- ▶ Only have the gas system maintained, repaired or altered by an authorised specialist workshop.
- ▶ Have the gas system checked by an authorised specialist workshop according to the national regulations before commissioning. This also applies for not registered vehicles. For modifications to the gas system have the gas system immediately checked by an authorised specialist workshop.
- ▶ The gas pressure regulator and exhaust gas pipes must also be inspected. The gas pressure regulator has to be replaced after 10 years at the latest. The vehicle owner is responsible for seeing that this is carried out.
- ▶ In case of a defect of the gas system (gas odour, high gas consumption) there is danger of explosion! Close regulator tap on the gas bottle immediately. Open doors and windows and ventilate well.
- ▶ If the gas system is defective: Do not smoke; do not ignite any open flames, and do not operate electric switches (light switches etc.).
- ▶ Before using the cooker make sure that there is sufficient ventilation. Open windows or the skylight.
- ▶ Do not use the gas cooker or gas oven for heating purposes.
- ▶ If there are several gas devices, each gas device must have its own gas isolator tap. If individual gas devices are not in use, close the respective gas isolator tap.
- ▶ Ignition safety valves must close within 1 minute after the gas flame has extinguished. A clicking sound is audible. Check function from time to time.
- ▶ The built-in gas devices are exclusively meant for use with propane or butane gas or a mixture of both. The gas pressure regulator as well as all built-in gas devices are designed for a gas pressure of 30 mbar.



- ▶ Propane gas is capable of gasification up to $-42\text{ }^{\circ}\text{C}$, whereas butane gas gasifies at $0\text{ }^{\circ}\text{C}$. Below these temperatures no gas pressure is available. Butane gas is unsuitable for use in winter.
- ▶ Regularly inspect the gas tube fitted to the gas bottle connection for tightness. The gas tube must not have any tears and must not be porous. Have the gas tube replaced by an authorised specialist workshop no later than ten years after the manufacturing date. The operator of the gas system must see to it that the parts are replaced.
- ▶ Due to its function and construction, the gas bottle compartment is a space which is open to the exterior. Never cover or block up the standard forced ventilations. Otherwise gas that is emitted can not be diverted to the outside.
- ▶ Do not use the gas bottle compartment as storage space as it is not moisture-proof.
- ▶ Secure the gas bottle compartment against unauthorised access. To do this, lock the compartment.
- ▶ The regulator tap on the gas bottle must be accessible.
- ▶ Only connect gas-operated devices (e.g. gas grill) which have been designed for a gas pressure of 30 mbar.
- ▶ The exhaust gas pipe must be fitted tightly to the heating system and to the vent and must be sealed. The exhaust gas pipe must not show any evidence of damage.
- ▶ Exhaust fumes must be able to escape into the atmosphere unhindered and fresh air must be able to enter unhindered. For this reason, keep the exhaust pipe and intake openings clean and unobstructed (e.g. free from snow and ice). For this reason, no snow walls or aprons may lie against the vehicle.

7.2 Gas bottles



- ▶ Gas bottles are only to be transported within the designated gas bottle compartment.
- ▶ Place the gas bottles in vertical position in the gas bottle compartment.
- ▶ Fasten the gas bottles so that they are unable to turn or tilt.
- ▶ If the gas bottles are not connected to the gas tube, always place the protective cap on top.
- ▶ Close the regulator tap on the gas bottle before the gas pressure regulator or gas tube are removed from the gas bottle.
- ▶ The gas pressure regulator or the gas tube must only be secured with a suitable gas spanner (Do **not** overtighten).
- ▶ Only use special gas pressure regulators with a safety valve designed for vehicle use. Other gas pressure regulators are not permitted and cannot meet the demanding requirements.
- ▶ Use the gas pressure regulator defroster if the temperature falls below $5\text{ }^{\circ}\text{C}$.
- ▶ The designated gas bottle compartment will accommodate two gas bottles, i. e. Calor Gas Butane/Propane or Camping Gaz. All gas bottles **must** be fitted with the appropriate regulator.



- ▶ Use the shortest possible tube lengths (150 cm max.) for external gas bottles.
- ▶ Never block the floor ventilation openings below the gas bottles.



- ▷ With some models, the gas bottle compartment is located right next to the conversion door. With these models, only open the gas bottle compartment when the conversion door is closed. Danger from damages.



- ▷ For gas-operated units the gas pressure must be reduced to 30 mbar.
- ▷ Connect gas pressure regulator complete with safety valve directly to bottle valve.

The gas pressure regulator reduces the gas pressure in the gas bottle down to the operating pressure of the gas devices.

- ▷ For filling and connecting the gas bottles in Europe the accessories shops have corresponding Euro filling sets and Euro bottle sets.
- ▷ Information available at the dealers or service centre.

7.3 Changing gas bottles



- ▶ When changing gas bottles, do not smoke or create any open fire.
- ▶ When you have changed the gas bottle, check whether gas escapes at the connection points and unions. Use a leakage search spray to spray the relevant connection point or union. These agents are available at the accessories shop.



Fig. 59 Gas bottle compartment

- Close the regulator tap (Fig. 59,1) on the gas bottle (Fig. 59,4). Pay attention to the direction of the arrow.
- Unscrew the gas pressure regulator (Fig. 59,2) along with the gas tube (Fig. 59,5) from the gas bottle with a suitable gas spanner.
- Release the fixing belts (Fig. 59,3) and take out the gas bottle.
- Place a filled gas bottle in the gas bottle compartment.
- Fix gas bottle in place with the fixing belts.
- Screw the gas pressure regulator with gas tube on the gas bottle and secure with a suitable gas spanner (Do **not** overtighten).

7.4 Gas isolator taps

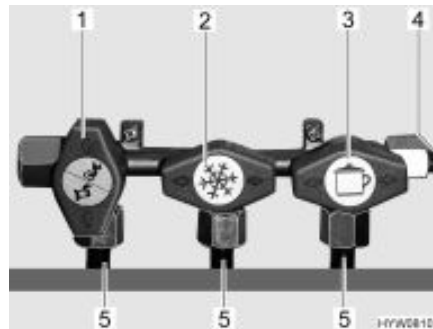

- 1 Heater/boiler
- 2 Refrigerator
- 3 Cooker
- 4 Gas pipe
- 5 Pipe to the gas appliance

Fig. 60 Symbols for the gas isolator taps

A gas isolator tap (Fig. 60) for every gas device is built into the vehicle. The gas isolator taps can be found under the cooker.

- Opening:*
- Position the gas isolator tap of the corresponding appliance parallel (Fig. 60,1) to the pipe (Fig. 60,5) leading to the gas appliance.
- Closing:*
- Position the gas isolator tap of the corresponding appliance transverse (Fig. 60,2 and 3) to the pipe (Fig. 60,5) leading to the gas appliance.

7.5 External gas connection



- ▶ If the external gas connection is not in use, always close the gas isolator tap.
- ▶ Only gas appliances with a suitable adapter should be connected to the external gas connection.
- ▶ Connect only external gas appliances which are designed for an operation pressure of 30 mbar.
- ▶ Once you have made the connection and opened the gas isolator tap, make sure that no gas is escaping at the connection point. If there is a leak in the external gas connection, gas will escape into the open air. Immediately close the gas isolator tap and the regulator tap on the gas bottle. Have the external gas connection checked by an authorised specialist workshop.
- ▶ When connecting an external gas appliance, make sure that there is nothing near the external gas connection that could cause a spark.
- ▶ Do not use the external gas connection to fill gas bottles. Observe the information stickers on the external gas connection.

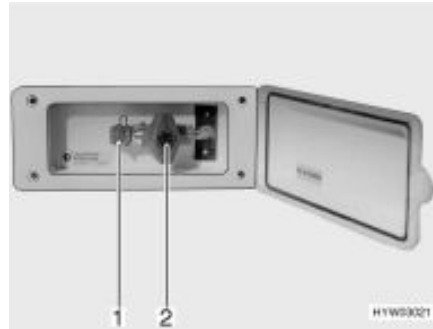

Fig. 61 External gas connection, gas isolator tap closed

The external gas connection (Fig. 61) is located at the rear or to the left or right of the vehicle depending on the model.

- Connect the external gas device to the connection point (Fig. 61,1).
- Open the gas isolator tap (Fig. 61,2).

7.6 DuoControl switching facility



▶ Do not use the switching facility in closed spaces.



▷ Also read the manufacturer's instruction manual.

The DuoControl is an automatic switching facility with a remote display for a two-bottle gas system. The DuoControl switching facility automatically switches gas supply from the primary bottle to the reserve bottle as soon as the primary bottle is either empty or no longer ready for operation. The gas appliances may still continue operation. The DuoControl switching facility is suitable for all commercial gas bottles from 3 kg to 33 kg.

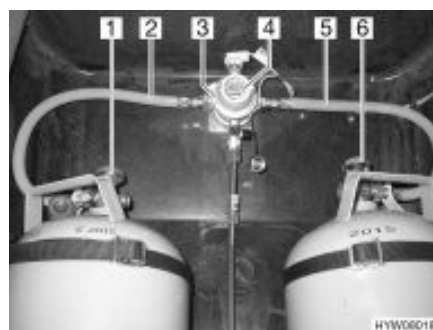

Fig. 62 DuoControl switching facility

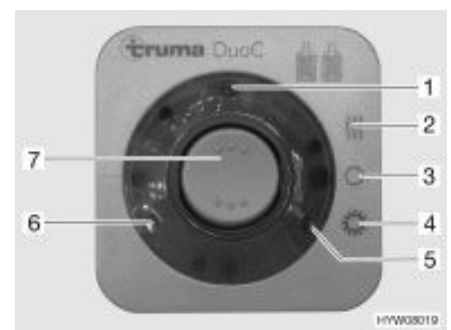

Fig. 63 Operating unit

Construction of the unit

The DuoControl switching facility consists of a reversing valve (Fig. 62,3) and an operating unit (Fig. 63). The reversing valve is installed between the gas tubes (Fig. 62,2 and 5). The knob (Fig. 62,4) on the reversing valve is used to select which of the gas bottles is to be used as a primary bottle and which is to be used as a reserve bottle.

The reversing valve is equipped with the regulator defroster Eis-Ex. This prevents damage to the gas system during the winter months.

Only the electrical functions can be switched at the operating unit (Fig. 63). The regulator taps on the gas bottles (Fig. 62,1 and 6) must be opened manually.

The reversing valve provides a constant gas pressure, regardless of which gas bottle is being drawn upon. The two indicator lamps on the operating unit indicate the level of the primary bottle. When the green indicator lamp (Fig. 63,6) illuminates, the primary bottle is full. When the red indicator lamp (Fig. 63,5) illuminates, the primary bottle is empty. In this case, the reserve bottle is used for the gas supply.

Operating modes The DuoControl switching facility has two operating modes:

- Winter operation "On and heating"
- Summer operation "On"

Putting into operation:

- Open the regulator taps on the gas bottles (Fig. 62,1 and 6).
- Use the knob (Fig. 62,4) on the reversing valve (Fig. 62,3) to select the gas bottle which is to be the primary source of gas (primary bottle). Always turn the knob as far as it will go.
- Switch on the DuoControl switching facility at the operating unit (Fig. 63). To do so, set the rocker switch (Fig. 63,7) to winter operation "On and heating" (Fig. 63,2) or to summer operation "On" (Fig. 63,4). The reversing valve is now deaerated. The yellow indicator lamp (Fig. 63,1) illuminates if the winter operation has been selected and the regulator defroster is activated.

Switching off:

- Set the rocker switch (Fig. 63,7) to "○" (Fig. 63,3). The yellow indicator lamp (Fig. 63,1) goes out.
- Close the regulator taps on the gas bottles (Fig. 62,1 and 6).

Remote display

The indicator lamps on the operating unit (Fig. 63,5 and 6) indicate in the vehicle interior whether the primary bottle is ready for operation.

Changing gas bottles

If the green indicator lamp (Fig. 63,6) stops illuminating during operation and the red indicator lamp (Fig. 63,5) illuminates, the gas bottle selected as primary bottle is empty and needs to be changed. The reserve bottle continues supplying the gas appliances with gas.



► When changing gas bottles, do not smoke or create any open fire.

Changing gas bottles:

- Close the regulator tap on the empty gas bottle.
- Unscrew the gas tube of the gas bottle.
- Connect the full gas bottle to the gas tube.
- Open the regulator tap on the gas bottle.
- Set the knob on the reversing valve with a half-turn, so that the newly replaced gas bottle will serve as a reserve bottle.

Chapter overview

This chapter contains instructions regarding the electrical system of the vehicle.

The instructions address the following topics:

- safety
- explanations of terms relating to the battery
- 12 V power supply
- installation of an inverter
- starter battery
- living area battery
- transformer/rectifier
- panel
- 240 V power supply
- connection to the 240 V power supply
- fuse rating
- electrical wiring

The operation of the electrical appliances of the housing body is described in chapter 9.

8.1 General safety instructions



- ▶ Only allow qualified personnel to work on the electrical system.
- ▶ All electronic devices (e.g. mobile telephones, radios, televisions or DVD players) which have been retrofitted to the vehicle and are operated during the journey must have certain features: These are the CE certification, the EMC inspection (electromagnetic compatibility) and the "e"-inspection.

Only in this way can the functional reliability of the vehicle be ensured. Otherwise the airbag may be triggered or interference to the on-board electronics may result.

The vehicle is a safe place during a storm (Faraday cage). However, to protect the electrical devices, disconnect the 240 V connection and retract the antennae as a precaution.

8.2 Terms

Off-load voltage

The off-load voltage is the voltage of the battery in idle condition, i. e. no current is consumed and the battery is not being charged.



- ▷ The battery must remain idle for a while before measuring. After charging the last time, or after the last current has been drained by consumers, wait approximately 2 hours before measuring the idle voltage.

Closed circuit current

Some electrical appliances, such as the clock and the indicator lamps, require continuous electric current, for this reason they are referred to as inactive appliances. This closed circuit current flows even if the device has been switched off.

Total discharge

Total discharge of the battery is imminent, if a battery is completely discharged by an active appliance and by closed circuit current and the off-load voltage falls below 12 V.



- ▷ Total discharge damages the battery.

Capacity

Capacity refers to the amount of electricity which can be stored in a battery. The capacity of a battery is given in ampere hours (Ah). The so-called K20 value is normally used.

The K20 value indicates how much current a battery is able to dispense over a time period of 20 hours without causing damage, or how much current is required to charge a flat battery within 20 hours.

For example, if a battery can dispense 4 amps for 20 hours, then it has a capacity of $4 \text{ A} \times 20 \text{ h} = 80 \text{ Ah}$.

If more current flows, the capacity of the battery reduces proportionately.

External influences, such as temperature and age may alter the storage capacity of the battery. Capacity details refer to new batteries operating at room temperature.



- ▷ Depending on battery technology, capacity details have a conversion factor of 1.3 to 1.7, which lowers the real capacity by this value.

8.3 12 V power supply



- ▷ Only connect devices with a maximum of 10 A to the sockets of the 12 V power supply.

8.3.1 Installation of inverter



- ▷ Retrofitting of an inverter can lead to damage to the electrical system. We will not be held liable for this damage.

The installation of a 240 V inverter results in a very high current load. For example an inverter with a power output of 800 W on the 12 V side has a current consumption of up to 75 A.

This current is much too big for the outputs on the transformer (see section 8.7.1).

If the inverter is connected directly to the battery, the current consumption of the inverter will not be indicated by panel. The display shows incorrect values. Due to the high discharging current, the terminal voltage in the battery drops significantly. The measuring system installed then detects undervoltage and could switch off the 12 V power supply. In addition the living area battery will be drained very quickly if an inverter is used. It is not possible to gain sufficient charge via the vehicle's alternator or the transformer.

8.3.2 Starter battery

The starter battery serves for starting the engine and supplies the electrical appliances of the base vehicle as well as optional devices such as the radio, navigation system or central locking system with voltage.

Position The starter battery is fitted in the footwell of the driver's cabin under the floor plate.

Discharging This section contains information regarding the discharge of the starter battery.



- ▷ Total discharge damages the battery.
- ▷ Once a battery with acid is discharged, it can freeze in temperatures of below zero. This damages the battery.
- ▷ Recharge battery in good time.

The starter battery will be totally discharged via a closed circuit current (inactive appliances). Inactive appliances are optional devices such as a radio, alarm system, navigation system or a central locking system. Inactive appliances discharge the starter battery when the vehicle engine is switched off. Low temperatures outside reduce the capacity available.

Charging This section contains information regarding the charging of the starter battery.



- ▶ The acid in the battery is poisonous and corrosive. Any contact with the skin or the eyes is to be avoided.
- ▶ In the case of charging with an external charger there is danger of explosion. Sparks can be caused by attaching the battery terminals. Only charge the battery in a well ventilated area and away from naked flames or possible sources of sparks. Batteries can develop and release gases.



- ▷ Charge the battery for at least 20 hours before laying up.
- ▷ Do not connect the battery cables to the wrong poles.
- ▷ If the starter battery or living area battery are disconnected, do not apply the ignition. There is a danger of short circuit from exposed cable ends.
- ▷ Before disconnecting or connecting the terminals of the battery, switch off the vehicle engine as well as the 240 V and 12 V power supplies and all appliances. Danger of short circuit!
- ▷ Observe the instruction manuals for the base vehicle and the charger.

The starter battery can only be fully charged with an external charger. When the vehicle is connected to the 240 V power supply, the transformer/rectifier charges the starter battery with a float charge only. Even in mobile operation, the vehicle engine alternator has a limited capability of completely charging the starter battery.

When charging the starter battery with an external charger, proceed as follows:

- Turn off the vehicle engine.
- Switch off the 12 V power supply on the panel. The indicator lamps or the displays on the panel go out.
- Switch off all gas appliances, all gas isolator taps and close the regulator tap on the gas bottle.
- Disconnect the starter battery from the vehicle (e.g. remove the battery terminals). There is a danger of short circuit when disconnecting the battery poles. For this reason, first disconnect the negative terminal on the starter battery and then the positive.
- Check that the external charger is turned off.
- Connect the external charger to the starter battery. Pay attention to the polarity: First connect the positive terminal "+" to the positive terminal of the starter battery, then connect the negative terminal "-" to the negative pole of the starter battery.
- Switch on the external charger.
- See the instructions for use of the connected charger for information concerning charge period required for the battery.
- See the specifications on the battery for information concerning its strength.
- Disconnect the charger in reverse order (the negative terminal first).
- Connect the battery terminals again (first the positive terminal).

8.3.3 Living area battery



- ▷ The dryfill battery must not be opened.
- ▷ Use only the built-in transformer/rectifier to load the living area battery.
- ▷ Prior to commencing a journey ensure the living area battery is fully charged. For this reason charge the living area battery for at least 20 hours before commencing the journey.
- ▷ During the trip, use every opportunity to charge the living area battery.
- ▷ Charge the living area battery for at least 20 hours after the journey.
- ▷ Charge the battery for at least 20 hours before laying up.
- ▷ When the living area battery is changed, only use batteries of the same type.
- ▷ If there are several living area batteries, always change all the batteries together. The batteries must **always** be the same age and have the same capacity.
- ▷ When changing the living area battery, use only batteries which meet the minimum capacity of the charger. Observe the separate instruction manual for the charger. Lower-capacity batteries will generate a great deal of heat when they are charged. Danger of explosion!
- ▷ If the living area battery is replaced and the charging unit does not provide at least 10 % of the rating of a new battery, install an auxiliary charging unit. Example: With a battery capacity of 80 Ah, the charging unit must supply at least 8 A charging current.



- ▷ Before disconnecting or connecting the terminals of the battery, switch off the vehicle engine as well as the 240 V and 12 V power supplies and all appliances. Danger of short circuit!
- ▷ If the starter battery or living area battery are disconnected, do not apply the ignition. There is a danger of short circuit from exposed cable ends.
- ▷ If there are two living area batteries: When changing, ensure that the batteries are properly installed. Install the batteries so that the positive terminal on one battery is lying next to the negative terminal of the other battery.
- ▷ If there are two living area batteries: When changing, ensure that the batteries are properly connected (see Installing the auxiliary battery).



- ▷ The battery is maintenance-free. Maintenance-free means:
 - It is not necessary to check the acid level.
 - It is not necessary to lubricate the battery poles.
 - It is not necessary to refill the distilled water.
 - Even a maintenance-free battery must be charged regularly.

When the vehicle is not connected to the 240 V power supply or the 240 V power supply is switched off, the living area battery supplies the living area with 12 V DC. The living area battery has a limited power supply only. For this reason, electrical appliances such as the radio and the lights should not be operated for a long time without using the 240 V power supply.

Position

The living area battery is fitted under the L-seating group and can be accessed by an external flap.

Discharging

The living area battery is discharged by the closed circuit current which some electrical appliances continuously require.



- ▷ Total discharge damages the battery.
- ▷ Recharge battery in good time.

A completely charged 80 Ah living area battery will be totally discharged via a closed circuit current (inactive appliances).

Low temperatures outside reduce the capacity available.

The self-discharge rate of the battery is also dependant on temperature. At 20 to 25 °C the self-discharge rate is approx. 3 % of the capacity per month. The self-discharge rate will increase with rising temperatures: At 35 °C the self-discharge rate is approx. 20 % of the capacity per month.

An older battery no longer has the complete capacity available.

The higher the number of active electrical appliances, the faster the energy of the living area battery is consumed.

Charging

Only use the transformer/rectifier to charge the living area battery. Therefore, connect the vehicle to a 240 V power supply system as often as possible.



- ▷ Charge the battery for at least 48 hours after a total discharge.
- ▷ At temperatures below 0 °C, a dryfill battery consumes less power. At approx. -15 °C, there will be no more power. The living area battery can no longer be charged.

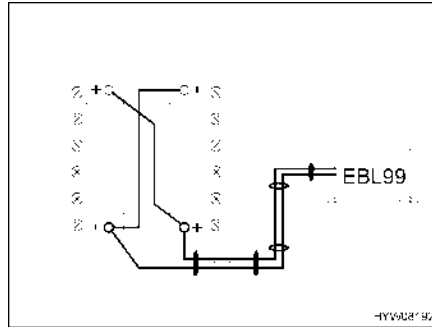

Fig. 64 Connection auxiliary battery

Installation of auxiliary battery

To allow all the batteries to be charged or discharged evenly, the batteries must be connected according to Fig. 64. The batteries are fitted to each other with the terminals, to ensure the lines are not incorrectly connected.



- ▷ Further information can be obtained in the separate documentation for the living area battery.

8.4 Transformer/rectifier (EBL 99)



- ▷ Do not cover the ventilation slots. Danger of overheating!



- ▷ Depending on the model, not all slots for the fuses are occupied.
- ▷ If there are several living area batteries, use an auxiliary charging unit.
- ▷ Further information can be obtained in the manufacturer's instruction manual.

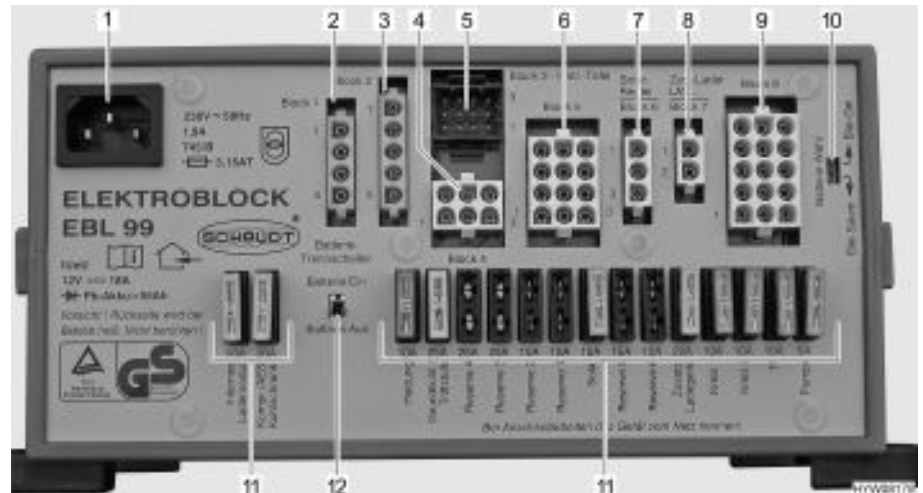

Fig. 65 Transformer/rectifier (EBL 99)

- 1 Main supply socket 240 V~
- 2 Block 1: Refrigerator output (D+, heating cartridge)
- 3 Block 2: Refrigerator output from starter battery, alternator D+
- 4 Block 4: Heating output, basic light (lighting in the entrance area), entrance step
- 5 Block 3: Panel outlet
- 6 Block 5: Reserve output 2, reserve 3, reserve 4, appliance with constant positive (e.g. satellite device, defroster)
- 7 Block 6: Solar charge regulator input (if fitted)
- 8 Block 7: Auxiliary charging unit input, fuel cell
- 9 Block 8: Appliance circuit output 1, appliance circuit 2, TV, water pump, reserve 1, reserve 5, reserve 6
- 10 Battery selector switch ("Blei-Säure/Blei-Gel") (lead acid/dryfill)
- 11 Fuses
- 12 Battery cut-off switch ("Batterie Ein/Aus" (battery On/Off))

Functions The transformer/rectifier has the following functions:

- The transformer/rectifier charges the living area battery. The transformer/rectifier charges the starter battery with a float charge only.
- The transformer/rectifier monitors the voltage in the living area battery.
- The transformer/rectifier distributes the current to the 12 V circuits and secures them. Devices with a maximum of 10 A can be connected to the sockets.
- The transformer/rectifier provides connections for a solar charge regulator, an auxiliary charging unit, as well as other control and monitoring functions.
- When the engine is turned off, the transformer/rectifier separates the starter battery electrically from the living area battery. This prevents the 12 V living area appliances from discharging the starter battery.
- The battery cut-off switch in the transformer/rectifier separates all the appliances from the living area battery.

The transformer/rectifier only works in conjunction with a panel.

The power in the transformer/rectifier (> 18 A) is divided into charging current and current to the appliances. The charging current is always just the portion that is not being used by any appliances. If the current to the appliances exceeds the current available, then the living area battery is discharged.

Position The transformer/rectifier is fitted under the L-seating group and can be accessed by an external flap.

8.4.1 Battery cut-off switch

The battery cut-off switch switches off **all** the appliances in the living area, even inactive ones. Even appliances such as the entrance step, basic lighting or the refrigerator will stop working. This prevents the living area battery from slowly discharging if the vehicle is not used for a longer period of time (e.g. temporary lay-up).

If the vehicle is connected to the 240 V power supply, the batteries can then be charged from the transformer/rectifier, even if the battery cut-off switch is switched off.

This also applies for charging via a solar installation or fuel cell.

8.4.2 Battery selector switch



- ▶ If the battery selector switch is set incorrectly, there is the danger of the formation of detonating (oxy-hydrogen gas). Danger of explosion!



- ▷ Incorrect setting of the battery selector switch damages the living area battery.
- ▷ The factory settings of the battery selector switch must not be changed.

8.4.3 Battery monitor



- ▷ You must fully recharge a discharged living area battery as soon as possible.

The battery monitor in the transformer/rectifier monitors the voltage in the living area battery.

If the voltage of the batteries falls below 10.5 V, the battery monitor in the transformer/rectifier switches off all the 12 V appliances. The battery cut-off switch is activated.

- Measures:*
- Switch off all electrical appliances that are not absolutely essential at the corresponding switch.
 - If necessary, use the 12 V main switch to switch the 12 V power supply back on for a short while. This is only possible, however, when the battery voltage is above 11 V. If the voltage is below this level, the 12 V power supply cannot be switched on again until the living area battery has been recharged.

8.4.4 Charging the battery

When the vehicle engine is running, the vehicle alternator recharges the living area battery and the starter battery. When the vehicle engine is switched off, the batteries are automatically disconnected from one another by a relay in the transformer/rectifier. This prevents the starter battery from being run down by electrical appliances in the living area. The starting capability of the vehicle is thus preserved. The terminal voltage of the living area battery or the starter battery can be read on the panel.

If the vehicle is connected to the 240 V power supply, the living area battery and the starter battery are automatically charged by the charger module on the transformer/rectifier. The starter battery is only charged with a float charge. The charging current is adapted to suit the charging condition of the battery. This ensures that it is not possible to overload the battery.

To make use of the maximum output from the charger module on the transformer/rectifier, switch off all electrical appliances during charging.

8.4.5 Retrofitting additional 12 V appliances

The electrical system in the living area of the vehicle can have additional appliances added. The optional devices are to be connected to the reserve outputs on the transformer. The output of the optional devices may not exceed the rating of the fuse (e.g. 15 A). Do not use fuses on the transformer/rectifier that are higher than those stated on the transformer/rectifier.

8.5 Panel (LT 95)

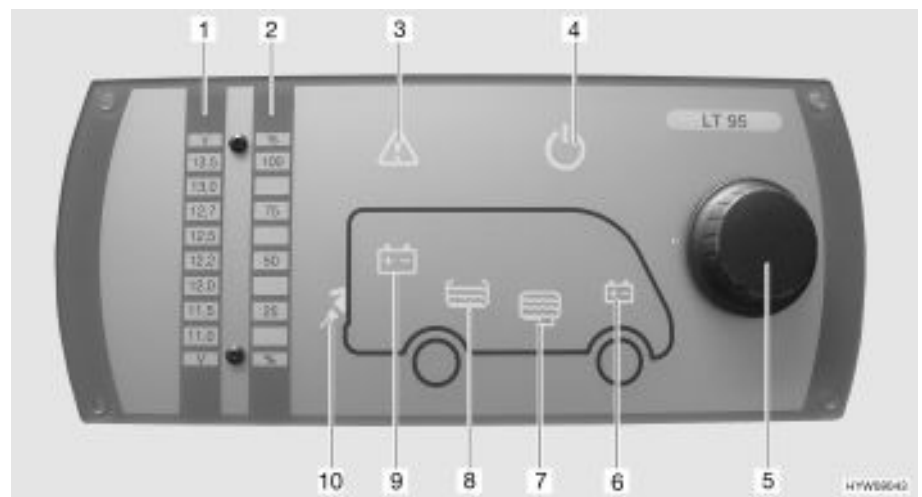

Fig. 66 Panel (LT 95)

- 1 Indicator scale for battery voltage
- 2 Indicator scale for tank fill level
- 3 Alarm warning light
- 4 12 V indicator lamp
- 5 Rotary knob
- 6 Starter battery symbol
- 7 Waste water tank symbol
- 8 Water tank symbol
- 9 Living area battery symbol
- 10 240 V indicator lamp



▷ Further information can be obtained in the manufacturer's instruction manual.

8.5.1 Switching the 12 V power supply On/Off

The rotary knob (Fig. 66,5) switches the panel and the 12 V power supply to the living area on and off.

Exception: Heating, basic light (lighting in the entrance area), step and the refrigerator are always ready to operate.

Switching on: ■ Press the rotary knob (Fig. 66,5): The 12 V living area power supply is switched on. The 12 V indicator lamp (Fig. 66,4) lights up.

Switching off: ■ Press the rotary knob (Fig. 66,5): The 12 V living area power supply is switched off. The 12 V indicator lamp (Fig. 66,4) goes off.



- ▷ When leaving the vehicle, switch off the main 12 V power supply at the rotary knob. This prevents any unnecessary discharge of the living area battery.
- ▷ Appliances, such as control units (e.g. charging units, solar charge regulator, defroster or panel) continue to take power from the battery capacity, even if the 12 V power supply on the panel is switched off. Therefore disconnect the living area battery from the 12 V power supply, if the vehicle will not be used for a long period of time.

8.5.2 Battery voltage display



- ▷ The battery voltage will be displayed for approx. 20 seconds after it has been called up.

Use the rotary knob (Fig. 66,5) for reading the voltage of the living area battery as well as that of the starter battery. The voltage is displayed on the indicator scale for battery voltage (Fig. 66,1).

Displays: ■ Turn the rotary knob (Fig. 66,5) until the symbol for the desired battery lights up.

Symbol	Signification
	Living area battery voltage is displayed
	Starter battery voltage is displayed

- Read the voltage from the indicator scale for battery voltage (Fig. 66,1).

The tables below will help you to correctly interpret the battery voltage display.

Notes regarding the battery voltage

Battery voltage (values during operation)	Mobile operation (vehicle moving, no 240 V connection)	Battery operation (vehicle stationary, no 240 V connection)	Power operation (vehicle stationary, 240 V connection)
Less than 11 V Danger of total discharge	No charging via the alternator	If appliances are switched off: Battery flat	No charging via the transformer/rectifier
	12 V power supply overload	If appliances are switched on: Battery overload	12 V power supply overload
11.5 V to 13 V	No charging via the alternator ¹⁾	Normal range	No charging via the transformer/rectifier ¹⁾
	12 V power supply overload ¹⁾		12 V power supply overload ¹⁾
13.5 V or more	Battery being charged	Occurs only briefly after charging	Battery being charged

¹⁾ If the voltage does not exceed this range for several hours.

Values for off-load voltage	Charging condition of the battery
Less than 12 V	Totally discharged
12.2 V	25 %
12.3 V	50 %
More than 12.8 V	100 %



▷ Total discharge causes irreparable damage to the battery.



▷ Measure the off-load voltage preferably several hours after the previous charging (e.g. in the morning) and not directly after a current drain.

8.5.3 Displaying the tank water level



▷ The tank fill level will be displayed for approx. 20 seconds after it has been called up.

Use the rotary knob (Fig. 66,5) for checking the fill level of the water tank or the waste water tank. The fill level is displayed on the indicator scale for the tank fill level (Fig. 66,2).

Displays: ■ Turn the rotary knob (Fig. 66,5) until the symbol for the desired tank lights up.

Symbol	Signification
	The level of the water tank is displayed
	The level of the waste water tank is displayed

- Read the level from the indicator scale for the tank fill level (Fig. 66,2).



- ▷ If the indicator scale displays flash while the fill level is being checked, a sensor error has occurred. Clean sensors or contact customer service.

8.5.4 Alarms

The Alarm warning light (Fig. 66,3) flashes if set limit values are exceeded or fallen below.

Battery alarm

The Alarm warning light (Fig. 66,3) flashes if the battery voltage falls below 11 V. If the 12 V power supply is switched on, the relevant battery symbol (Fig. 66,6 or 9) also lights up and "11.0" starts flashing on the indicator scale for battery voltage (Fig. 66,1). Danger of total discharge.



- ▷ Total discharge damages the battery.



- ▷ If the voltage of the batteries falls below 10.5 V, the battery monitor in the transformer/rectifier switches off all the 12 V appliances.

Measures:

- When the battery alarm comes on, switch off all appliances and charge the battery, either by mobile operation or by connection to a 240 V power supply.

Tank alarm

The Alarm warning light (Fig. 66,3) starts to flash and the corresponding tank symbol (Fig. 66,7 or 8) lights up as soon as the water tank is empty or the waste water tank is full.

Measures:

- Fill water tank or empty waste water tank.

240 V indicator lamp



- ▷ If the vehicle is connected to the 240 V power supply, the 240 V indicator lamp is lit even if the 12 V power supply is switched off via the rotary knob.

The 240 V indicator lamp (Fig. 66,10) illuminates whenever line voltage is available at the transformer/rectifier input.

8.6 240 V power supply



▶ Only allow qualified personnel to work on the electrical system.

The 240 V power supply provides electricity for:

- sockets with earth contact for appliances with maximum 10 A
- refrigerator
- transformer/rectifier
- an auxiliary charging unit
- air conditioning unit

The electrical appliances connected to the 12 V power supply of the living area are supplied with voltage by the living area battery.

Connect the vehicle to an external 240 V power supply system as often as possible. The charger module in the transformer/rectifier automatically charges the living area battery. In addition to this, the starter battery is charged with a float charge of 2 A.

Depending on the equipment, optional devices are fuse-protected by their own two-pole automatic circuit breaker (16 A).

8.6.1 240 V connection



▶ The external 240 V power supply must be protected by fuse with a fault current protection switch (FI-switches, 30 mA).



- ▷ For the connection points on camp sites (camping distributors) highly sensitive fault current protection switches (FI-switches, 30 mA) are obligatory.
- ▷ The vehicle is already equipped with a fault current protection switch (FI-switch).

The vehicle can be connected to an external 240 V power supply. The cable may have a length of maximum 25 m.

8.6.2 Power cable for external 240 V connection



▶ Completely unwind the cable on cable drums to prevent overheating.

Power cable

- Three-core (3 x 2.5 mm²) flexible rubber sheathed cable
- Maximum 25 m in length
- 1 plug with earth contact
- 1 socket with earth contact (plug-in devices according to EN 60309)

Connection possibilities

For your power cable, we recommend using a CEE connection cable with a CEE plug and coupling. If this type of connection is not feasible, we recommend the following combination with a safety plug:

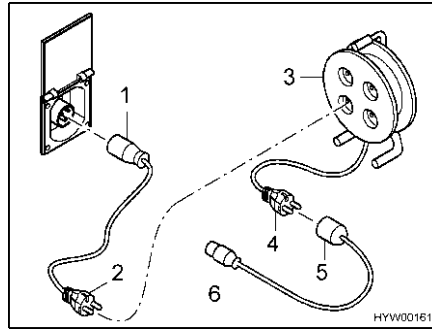

Fig. 67 Connection possibilities 240 V connection

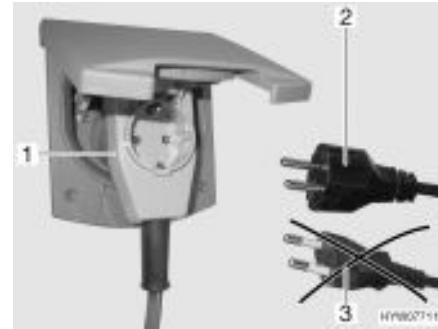

Fig. 68 Connecting an angled connector with socket

- Adapter cable:
CEE 17 socket with earth contact (Fig. 67,1) – plug with earth contact (Fig. 67,2)
- Cable reel:
Socket with earth contact (Fig. 67,3) – plug with earth contact (Fig. 67,4)
- Adapter cable:
CEE 17 socket with earth contact (Fig. 67,5) – plug with earth contact (Fig. 67,6)



▶ When using a CEE 17 angled connector with rear socket (Fig. 68,1) only use a rubberised and sealed IP 44 socket with earth contact (Fig. 68,2). Do not use sockets without earth contact (Fig. 68,3). Danger of electrocution!

Depending on the design, the flap for the 240 V connection is designated with the symbol .

Connecting the power cable:



- Swivel external flap upwards.
- Insert connector.
- ▷ Depending on the design, disconnect the connector before removing it.

8.7 Fuses



- ▶ Only replace defective fuses when the cause of the defect is known and has been remedied.
- ▶ Replace defective fuses only after the power supply has been turned off.
- ▶ Never bridge or repair fuses.
- ▶ Only replace faulty fuses with a new fuse with the same rating.

8.7.1 12 V fuses

The appliances connected to the 12 V power supply in the living area are fused individually. The fuses are accessible at different positions in the vehicle:

- on the transformer/rectifier
- on the fuse holder on the transformer/rectifier

- under the front passenger's seat
- on the starter battery

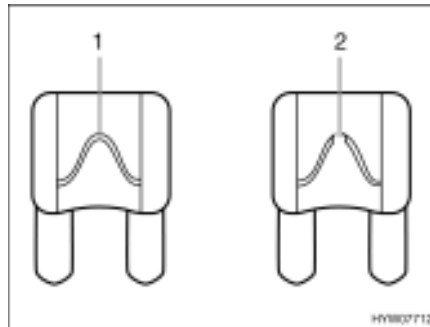

- 1 Unbroken fuse element
- 2 Broken fuse element

Fig. 69 12 V fuse

An intact 12 V fuse can be detected by the unbroken fuse element (Fig. 69,1). If the fuse element is broken (Fig. 69,2), change the fuse.

Before changing fuses, take the function, value and colour of the relevant fuses from the following specifications. When changing fuses, only use flat fuses with the values shown below.

Fuses on the starter battery

The fuses are installed in the vicinity of the starter battery.

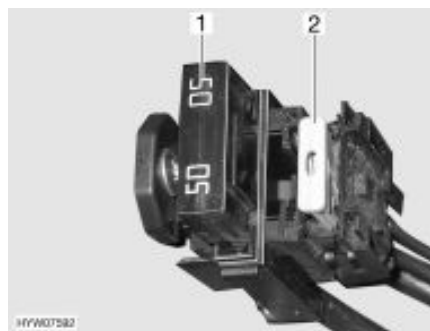

- 1 Jumbo flat fuse 50 A/red (for the transformer/rectifier)
- 2 Flat fuse 20 A/yellow (for the refrigerator)

Fig. 70 Fuses on the starter battery

Fuses on the living area battery

The fuses are fitted under the living area battery next to the transformer/rectifier.

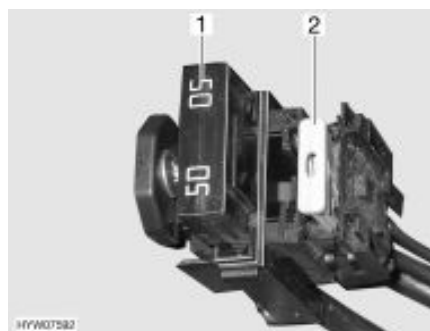

- 1 Jumbo flat fuse 50 A/red (for the transformer/rectifier)
- 2 Flat fuse 2 A/grey (for battery sensor, living area battery)

Fig. 71 Fuses on the living area battery

Fuses on the fuse holder

The fuses are fitted next to the transformer/rectifier. The fuses are secondary fuses for reserve 4 (25 A) on the transformer/rectifier.

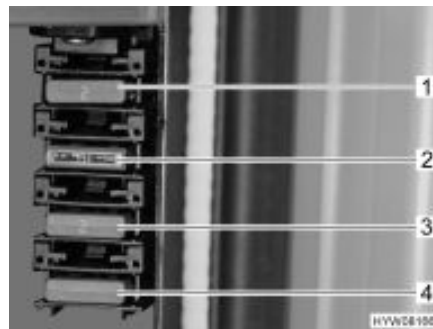

- 1 Flat fuse 2 A/grey (refrigerator control)
- 2 Flat fuse 10 A/red (satellite system)
- 3 Flat fuse 2 A/grey (electric pull-down bed)
- 4 Flat fuse (spare)

Fig. 72 Fuses on the fuse holder

Fuses on the relay box AD01 Fiat base vehicle

A relay box (AD01) is installed in the front passenger seat console. The relay box helps generate the signals for the chassis lighting not provided by the base vehicle. The relay box can be used anywhere.

The circuit used by us can vary from the circuit provided by the manufacturer. Consequently, the circuit can also vary from the display on the relay box type plate, which the manufacturer affixed.

FuNo	Function	Value/colour	Appliances
B2	Cl. 15 (Ignition On)	15 A blue (for the skylight, electrically operated: 10 A red)	Clamp 15 of the trailer coupling, signal for daytime running light, curve light, spotlight cleaning for Xenon, living room fan heater
B3	Cl. 30 (constant positive)	15 A blue	Signal for curve light, spotlight cleaning and level control for Xenon, electrically operated blind for windscreen
B5	Signal D+	Internal polyswitch (2 A)	D+ for transformer/rectifier, refrigerator, satellite system
B6	Spare	15 A blue	
B7	Cl. 15 (Ignition On)	5 A light brown	Front side marker lights (white/red), side marking lamps (yellow)

Fuses on the transformer/rectifier EBL 99

Function	Value/colour
Internal charger module	20 A yellow
Compressor refrigerator/AES refrigerator	20 A yellow
Heater	10 A red
Basic light/electrically operated entrance step/central locking system	15 A blue
Reserve 4 (satellite antenna, defroster, control panel for pull-down bed)	25 A white
Reserve 3 (air conditioning unit, sound system)	15 A blue
Reserve 2 (12 V additional plug socket, drive for electrical pull-down bed)	10 A red

Function	Value/colour
Spare 1 (optional devices gas system)	2 A grey
Solar	15 A blue
Reserve 5 (TV connection in rear)	10 A red
Reserve 6 (12 V additional plug socket)	10 A red
Auxiliary charging unit	20 A yellow
Circuit 1	15 A blue
Circuit 2	15 A blue
TV	10 A red
Water pump	5 A beige

Fuse for the Thetford toilet (swivel toilet)

The fuse is located in the locker wall of the sewage tank.



1 Flat fuse 3 A/purple

Fig. 73 Fuse for the Thetford toilet

Changing:

- Open the flap for the sewage tank on the outside of the vehicle.
- Completely remove the sewage tank.
- Replace fuse (Fig. 73,1).

Fuse for the Thetford toilet (fixed seat)

The fuse is located in the locker wall of the sewage tank.

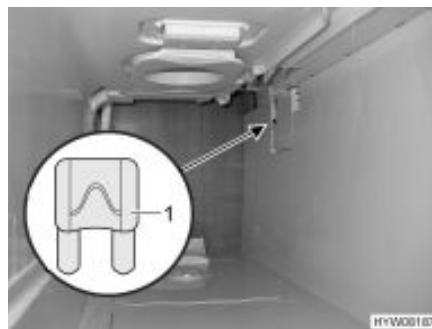

1 Flat fuse 3 A/purple

Fig. 74 Fuse for the Thetford toilet

Changing:

- Open the flap for the sewage tank on the outside of the vehicle.
- Remove the sewage tank and swing out the flap in the housing panel.
- Replace fuse (Fig. 74,1).

8.7.2 240 V fuse



- ▷ Check the fault current protection switch for each connection to the 240 V power supply, at least once every 6 months.

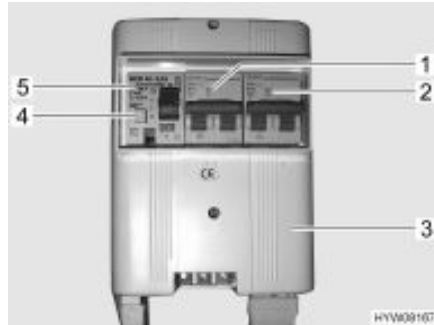

Fig. 75 240 V fuse box with safety cut-out and RCD

A fault current protection switch (RCD) (Fig. 75,5) in the fuse box (Fig. 75,3) protects the complete vehicle from fault current (0.03 A).

The downstream safety cut-out (10 A) (Fig. 75,1) secures the 240 V sockets, the transformer/rectifier, the auxiliary charging unit and the refrigerator.

For vehicles with special equipment, e.g. hot air heater with electric heating rod or roof air conditioner, an additional safety cut-out (16 A) (Fig. 75,2) secures the device.

The fuse box is installed in the wardrobe or under the rear bed.

Checking fault current protection switch:

- When the vehicle is connected to the 240 V power supply, press the test button (Fig. 75,4). The fault current protection switch (RCD) must be activated.

8.8 Circuit diagrams

8.8.1 Block diagram 240 V

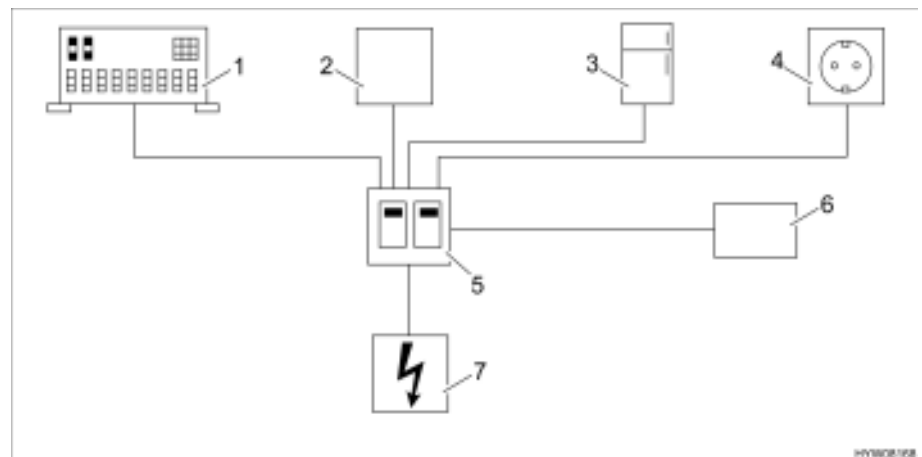

Fig. 76 240 V circuit diagram

- 1 Transformer/rectifier
- 2 Auxiliary charging unit
- 3 Refrigerator
- 4 Sockets
- 5 Automatic circuit breaker
- 6 Optional device (e.g. air conditioning unit)
- 7 240 V connection

Fig. 76 shows a schematic diagram of the 240 V network.

8.8.2 Block diagram 12 V

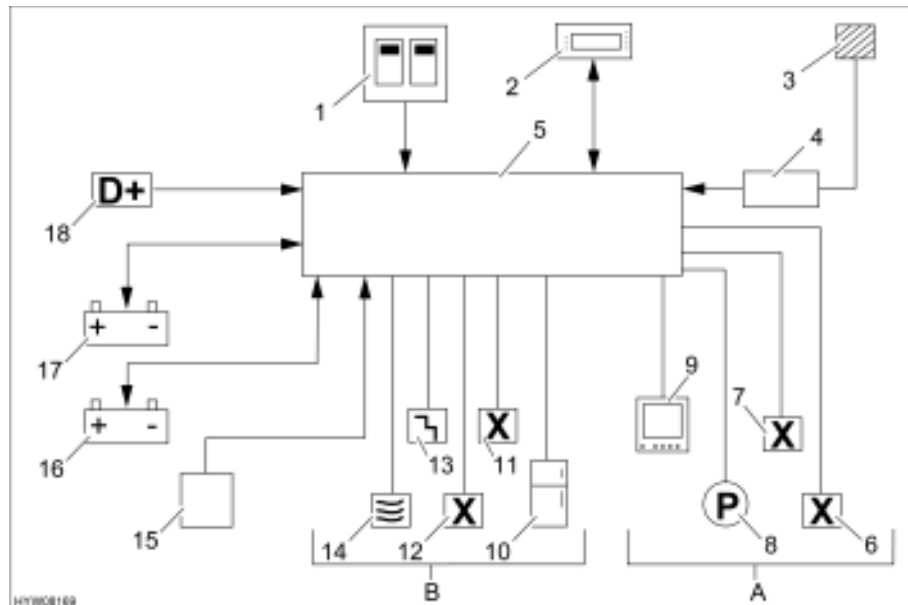

Fig. 77 12 V circuit diagram

1	240 V automatic circuit breaker
2	Panel with 12 V main switch
3	Solar
4	Solar regulator
5	Transformer/rectifier with battery cut off switch
A	Light, consumer circuits can be switched on/off via 12 V main switch
6	Spare 1, 2, 3, 5 and 6
7	Circuit 1, circuit 2
8	Water pump
9	TV set
B	Basic supply can be switched on/off via battery cut-off switch
10	Refrigerator
11	Spare 4 (special equipment, e.g. defroster)
12	Basic light
13	Entrance step
14	Heater
15	Auxiliary charging unit
16	Living area battery
17	Starter battery
18	(D+)

Fig. 77 shows a schematic diagram of the 12 V network.

Chapter overview

This chapter contains instructions regarding the appliances of the vehicle.

The instructions refer exclusively to the operation of the appliances.

Further information about the appliances can be found in the instruction manuals for the appliances, included separately with the vehicle.

The instructions address the following topics:

- heater
- boiler
- gas cooker
- gas oven
- refrigerator

9.1 General



- ▷ The heat exchanger of the Truma hot-air heater has to be replaced after 30 years. The heat exchanger of the Alde hot-water heater has to be replaced after 10 years. Only the manufacturer of the heater or an authorised specialist workshop is allowed to replace the heat exchanger. The operator of the heater must see to it that the parts are replaced.
- ▷ For safety reasons, spare parts for pieces of heating appliances must correspond with manufacturer's instructions and be permitted by the manufacturer as a spare part. These spare parts may only be fitted by the manufacturer or an authorised specialist workshop.



- ▷ Further information can be obtained in the instruction manual for the respective appliance.

The heater, boiler, cooker and refrigerator are fitted depending on the model of the vehicle.

In this instruction manual a description is given only for the operation of the appliances and their particular features.

To operate gas appliances, first open the regulator tap on the gas bottle and the gas isolator tap corresponding to the appliance.

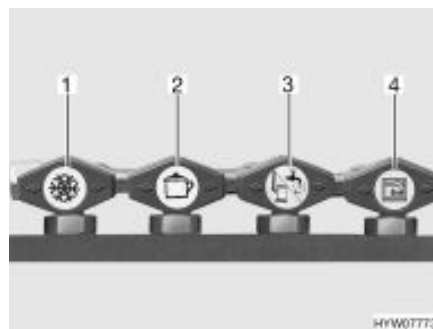

- 1 Refrigerator
- 2 Cooker
- 3 Heater/boiler
- 4 Oven

Fig. 78 Symbols for the gas isolator taps

9.2 Heater



- ▶ Never let gas escape unburned due to danger of explosion.
- ▶ Never run the heater in gas operation when refuelling, on ferries or in the garage. Danger of explosion!



- ▶ Never operate the heater in gas operation in closed spaces (e.g. garages). Danger of poisoning and suffocation!
- ▶ Do not use the space behind the heater as a storage compartment.

When lighting the heater for the first time a small amount of smoke and odour will occur. Immediately set the operating switch of the heater to its highest position. Open doors and windows and ventilate well. Smoke and odour will disappear by themselves after a while.

9.2.1 Models with waste gas vent on the right-hand side of the vehicle



- ▶ If the awning is put up and the heater is running in gas operation, exhaust gases from the heater can escape into the awning area. Danger of suffocation! Make sure the area is sufficiently ventilated.

9.2.2 To heat properly



Fig. 79 Air outlet nozzle

Hot air distribution

Several air outlet nozzles (Fig. 79) are built into the vehicle. Pipes conduct the warm air to the air outlet nozzles. Turn the air outlet nozzles in a suitable position so the air can escape as required. To avoid draft close the air outlet nozzles on the dashboard and set the air distribution of the base vehicle to air circulation.

Adjusting the air outlet nozzles

- Fully open: Full hot air stream
- Half or partially open: Reduced hot air stream

When five air outlet nozzles are completely opened, less warm air escapes through each nozzle. However, if only three air outlet nozzles are opened, more warm air flows out of each nozzle.

9.2.3 Truma hot-air heater



- ▷ When there is a danger of frost the heater is not in operation, empty the heating system.
- ▷ The circulation fan is automatically switched on when the hot-air heater is activated, and it stays on. This puts an immense strain on the living area battery, if the vehicle is connected to an external 240 V power supply. Take into consideration that the living area battery only has limited reserves of energy.

Depending on the equipment, different heaters are installed in the vehicles. The heaters differ with regard to the energy type with which they can be operated.

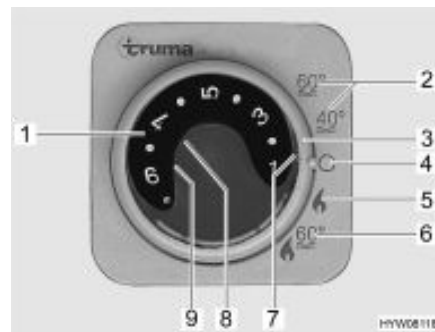

- 1 Temperature control knob
- 2 Summer operation water temperature 40 °C or 60 °C
- 3 Rotary switch
- 4 Off
- 5 Winter operation "Heater without boiler"
- 6 Winter operation "Heater and boiler"
- 7 Green indicator lamp "Heating operation"
- 8 Red indicator lamp "Fault" (dependent on model)
- 9 Yellow indicator lamp "Boiler heating-up phase"

Fig. 80 Operating unit for heater/boiler

Operating modes

All heaters have two operating modes:

- Winter operation
- Summer operation

It is only possible to heat the vehicle in the "Winter" operating mode. With the "Summer" operating mode only water in the boiler is heated. It is not possible to heat the vehicle in this operating mode.

Selecting operating mode:

- Set the operating mode using the rotary switch (Fig. 80,3).

The power supply of the heater cannot be interrupted by means of the 12 V main switch.

Variant: Heater with gas operation

The heater is operated exclusively with gas.

Winter operation

The heater selects the necessary burner setting according to the required room temperature. When the required room temperature is reached, the burner is switched off. In "Heater and boiler" operating mode (Fig. 80,6) water in the boiler is also heated. In the operating mode "Heater without boiler" (Fig. 80,5) the heater can be operated with an empty boiler.

Switching on:

- Open the regulator tap on the gas bottle and the gas isolator tap "Heater/boiler".
- Turn the temperature control knob (Fig. 80,1) on the operating unit to the desired heating level.
- Set rotary switch (Fig. 80,3) to winter operation "Heater without boiler" (Fig. 80,5) or to winter operation "Heater and boiler" (Fig. 80,6).

Green indicator lamp (Fig. 80,7) is on.

The circulation fan automatically switches on when the heater is activated.

Switching off:

- Set the rotary switch (Fig. 80,3) to "0" (Fig. 80,4).
- Close the gas isolator tap "Heater/boiler" and the regulator tap on the gas bottle.

After switching off the heater, the circulation fan may still run for a moment to use up the residual heat.

Summer operation

It is not possible to heat the vehicle in "Summer" operating mode. In "Summer" operating mode, only the water in the boiler is heated.

**Variant: Heater with gas
and 240 V electrical
operation**

- ▷ 240 V electrical operation is only possible when the vehicle is connected to the 240 V power supply.
- ▷ Select the output level for 240 V electrical operation so that it corresponds to the fuse protection of the 240 V connection (900 W for 3.9 A fuse, 1800 W for 7.8 A fuse).
- ▷ When the heater on the operating unit is set to summer operation and the energy selector switch is set to mixed operation, the heater still runs only in 240 V operation. The gas burner is not switched on.

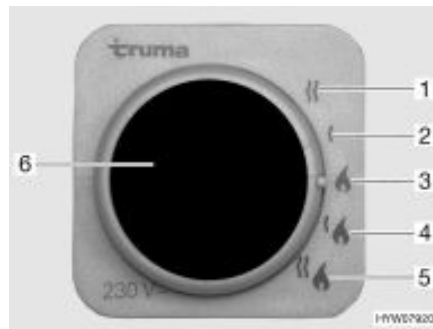

- 1 240 V electrical operation (1800 W)
- 2 240 V electrical operation (900 W)
- 3 Gas operation
- 4 Gas and 240 V electrical operation (900 W)
- 5 Gas and 240 V electrical operation (1800 W)
- 6 Yellow indicator lamp "240 V electrical operation"

Fig. 81 Energy selector switch for heater/boiler

The heater can be operated with different types of energy:

- Gas operation (Fig. 81,3)
- 240 V electrical operation with the output levels 900 W (Fig. 81,2) or 1800 W (Fig. 81,1)
- Gas and 240 V electrical operation (mixed operation) with the output levels 900 W (Fig. 81,4) or 1800 W (Fig. 81,5)

The combination gas operation and 240 V electrical operation reduces the heating-up time (only possible when the heater on the operating unit (Fig. 80) is set to winter operation).

When 240 V electrical operation is selected, the yellow indicator lamp illuminates (Fig. 81,6).



- ▷ Further information can be obtained from the separate "Gas heater" instruction manual.
- ▷ For further information about the use of the boiler see section "Boiler".

9.2.4 Alde hot-water heater



- ▷ Never run hot-water heater without heating fluid. Observe notes in chapter 12.
- ▷ Never drill holes in the floor. This might damage the hot-water pipes.



- ▷ The circulating pump must always be turned on when the hot-water heater is in operation.
- ▷ We recommend to bleed the heating system after the initial heater operation and to check the glycol content. Observe notes in chapter 12.
- ▷ When the heater is turned on, it starts with the last settings used.



- ▷ For further information, see the separate manufacturer's instruction manual and observe the maintenance instructions found in chapter 12.
- ▷ For further information about the use of the boiler see section "Boiler".

Operating unit

The operating unit is divided into two sections:

- Display (touch screen)
- Control buttons

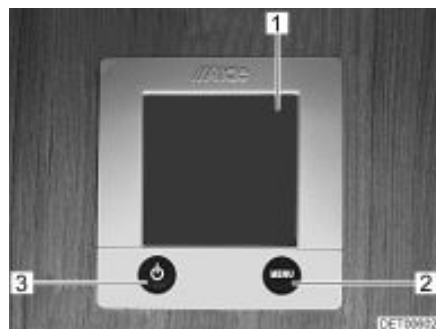

- 1 Display (touch screen)
- 2 "Menu" button
- 3 On/Off button

Fig. 82 Operating unit for hot-water heater



- ▷ When no button is pressed, the operating unit automatically switches to home position after two minutes.
- ▷ Changes to the settings are saved automatically after 10 seconds.

Control buttons

The control buttons have the following functions:

Pos. in Fig. 82	Button	Function
2	MENU	Open adjustment menu
3		Activate heating

Display

The display (Fig. 82,1) is designed as a touch screen. Touching the symbols calls up the relevant function.

Start screen





The Start screen appears on the display after the heater is switched on. The Start screen contains the following information:

Symbol	Signification
	This symbol appears when the circulating pump is activated
	This symbol appears when a switching facility for gas cylinders is activated
	This symbol appears when a voltage of 240 V is present at the heater
	The internal temperature is displayed next to this symbol
	The external temperature is displayed next to this symbol if an external sensor is fitted

Adjustment menu

The "MENU" button calls up the adjustment menu. The meanings of the individual symbols are described in the following table.

The values can be increased or reduced via the "+" or "-" symbols.

Symbol	Signification
	Set the desired temperature of +5 °C to +30 °C
	Set the water temperature in the boiler
	Set the heat output in electrical operation
	Activate the function "Heating in gas operation"
	Call up the enabling menu for the tool menus

Tool menus

The various heater functions can be called up and adjusted via the tool menus. The arrow symbols are used to change between the menus. The meanings of the individual symbols are described in the manufacturer's instruction manual.

Selecting the operating mode

The hot-water heater can be operated with the following energy sources:

- Gas operation
- 240 V electrical operation
- Gas and 240 V electrical operation

The operating mode is selected from the operating unit.

Selecting gas operation:

- Press the "On" button next to the "▲" symbol. The gas operation is activated.

Selecting 240 V electrical operation:

- Press the "+" button next to the "⚡" symbol until the desired heat output is reached.
- ▷ Select the output level during 240 V electrical operation in such a way that it corresponds to the 240 V connection protection:
 - Level 1 (1050 W) at 6 A
 - Level 2 (2100 W) at 10 A
 - Level 3 (3150 W) at 16 A



Selecting gas and 240 V electrical operation:

- Select gas operation and 240 V electrical operation on the operating unit.
- ▷ If gas and 240 V electrical operation is selected and if the vehicle is connected to the 240 V power supply, then the hot-water heater at first only operates in 240 V electric operation. Only if the heat output is insufficient does the gas operation also automatically switch on.
- ▷ The gas operation is only possible when the regulator tap on the gas bottle and the gas isolator tap are opened.
- ▷ 240 V electrical operation is only possible when the vehicle is connected to the 240 V power supply.



When the heater is turned on, it starts with the last set operating mode.

Switching on the heater:

- Press "⏻" button. The Start screen appears in the display. The heater starts automatically.

Switching the heater off:

- Press "⏻" button. The heater is turned off.

Heat distribution

In the vehicle, a stopcock for the heating pipes is located in the rear. The flow is released or blocked with the stopcock.

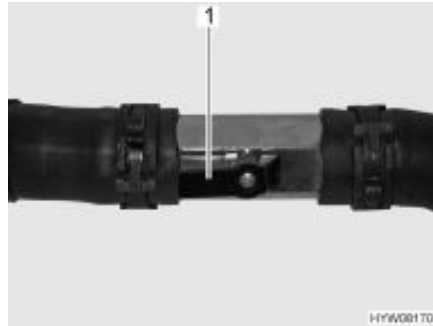

Fig. 83 Stopcock is open

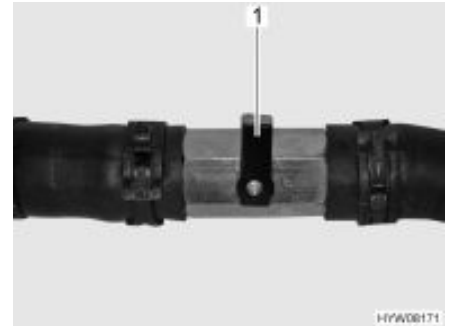

Fig. 84 Stopcock is closed

Position

Depending on the model, the stopcock is located at various points in the rear of the vehicle.

Opening the heating circuit:

- Set the lever (Fig. 83,1) of the stopcock parallel to the pipe (Fig. 83).

Locking the heating circuit:

- Set the lever (Fig. 84,1) of the stopcock at right angles to the pipe (Fig. 84).

Alde heat exchanger



- ▷ The heat exchanger only works when the vehicle engine is running.
- ▷ If the heat exchanger is not being used (as in the summer), the heat exchanger on the stopcock should be shut off.

The heat exchanger can be used to heat the living area of the vehicle during travel without operating the hot-water heater in the living area.

The heat exchanger is connected to the vehicle engine's cooling circuit and thus has the same function as the vehicle heater.

Heat output is set with the living area's heating regulator.

The heat exchanger stopcock is located directly on the exchanger.

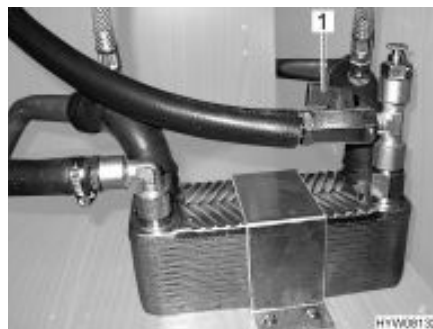

Fig. 85 Alde heat exchanger

Position

The heat exchanger is built into the passenger's seat console.

Turning on:

- Set stopcock handle (Fig. 85,1) parallel to the pipe.

Shutting off:

- Set drain cock handle (Fig. 85,1) at a right angle to the pipe.

Alde auxiliary circulating pump



- ▷ The auxiliary circulating pump works only if the heat exchanger has been installed and started, and the hot-water heater is running.



Fig. 86 Operating switch for auxiliary circulating pump

The auxiliary circulating pump can be used to heat the vehicle engine when parked.

The auxiliary circulating pump is connected to the vehicle engine's cooling circuit and thus functions as an engine heater.

The switch (Fig. 86,1) for the auxiliary circulating pump is located next to the hot-water heater operating unit. The yellow indicator lamp (Fig. 86,2) illuminates when the pump is operated.

Auxiliary fan



Fig. 87 Switch for auxiliary fan



Fig. 88 Intake opening on the inlet shaft

Position

Depending on the model, radiators with integrated auxiliary fans are installed in the seat consoles. The auxiliary fans ensure improved distribution of heat throughout the vehicle.

Each auxiliary fan has two output levels.

The switch (Fig. 87,1) controls the auxiliary fans. The switch is located on the inside of the driver's seat console (Fig. 87).

Switch functions

Switch position	Function
0	Off
I	Low fan output
II	High fan output



▷ When the fan is operating, the intake opening on the inlet shaft must not be covered or blocked.

An intake opening (Fig. 88,1) is installed on the inlet shaft (Fig. 88).

When the fan is switched on, the cold air is extracted from the inlet shaft at the same time via the intake opening.

Switching on: ■ Set the switch (Fig. 87, 1) to the "I" position or the "II" position.

Switching off: ■ Set switch to the central position "0".

9.2.5 Independent vehicle heater



- ▶ Do not operate the independent vehicle heater in closed spaces. Danger of suffocation!
- ▶ Do not operate the independent vehicle heater at petrol stations. Danger of explosion!

The inside and the engine can be heated with the independent vehicle heater. The heating of the engine can be switched off.

The independent vehicle heater can be turned on and off manually or with a timer. The time for the heating to start can be exactly preselected from 1 minute to 24 hours. It is possible to program three switching on times, of which only one can be activated. The maximum permitted operation time is 60 minutes.

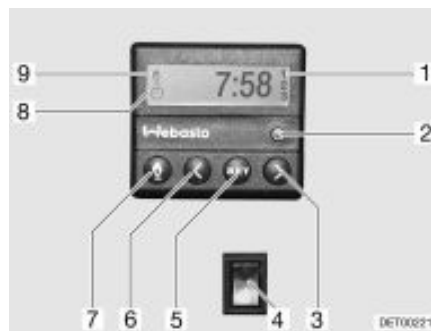

Fig. 89 Operating unit for independent vehicle heater

Switching on manually: ■ Press the button (Fig. 89,7). The heating mode is displayed by the symbol (Fig. 89,9). The fan will only be switched on when there is a coolant temperature of 30 °C.

Switching off manually: ■ Press the button (Fig. 89,7). The symbol (Fig. 89,9) goes off.

Switching on the engine heating: ■ Press the lower part of the switch (Fig. 89,4). Engine is preheated. The fan is switched on immediately.

Switching off the engine heating: ■ Press the upper part of the switch (Fig. 89,4). Engine stays cold.

Setting the time: ■ Press the button (Fig. 89,2). The time setting is displayed by the symbol (Fig. 89,8).

■ Set the time with the buttons (Fig. 89,3 and 6).

Programming heating start: ■ Press the button (Fig. 89,5).

■ Set the switching on time within ten seconds, with the buttons (Fig. 89,3 and 6).

Selecting programmed switching on time:

- Keep pressing button (Fig. 89,5) until the selected programme number (Fig. 89,1) appears in the display.

9.2.6 Auxiliary heat exchanger



- ▶ Do not operate the auxiliary heat exchanger at petrol stations. Danger of explosion!



- ▶ The fan on the auxiliary heat exchanger can be used for ventilation.
- ▶ The heat output is continuously adjusted.

The auxiliary heat exchanger is built into the bench seat.

The auxiliary heat exchanger may be used to provide the vehicle's living area with additional heat during the journey.

The auxiliary heat exchanger is integrated into the heat circulation of the base vehicle and is therefore only in operation when the vehicle engine is running.



Fig. 90 Operating controls for auxiliary heat exchanger

Position The auxiliary heat exchanger is built into the passenger's seat console.

Switching on:

- Turn the control knob (Fig. 90,1) of the flow control to the desired position. The water circulation is open.
- Turn the fan switch (Fig. 90,2) for the circulation fan in a clockwise direction.

Switching off:

- Turn the fan switch (Fig. 90,2) to "0".
- Turn the control knob (Fig. 90,1) of the flow control to its initial position.

9.3 Boiler



- ▶ Never let gas escape unburned due to danger of explosion.
- ▶ Never run the boiler in gas operation when refuelling, on ferries or in the garage. Danger of explosion!
- ▶ Never operate the boiler in gas operation in closed spaces (e.g. garages). Danger of poisoning and suffocation!
- ▶ The water in the boiler can be heated up to 65 °C. Risk of scalding!



- ▷ Never use boiler when empty.
- ▷ If the boiler is not being used, empty it if there is any risk of frost.
- ▷ Only operate the boiler with the maximum temperature setting if you require a large quantity of warm water. This protects the boiler against the build-up of limescale.



- ▷ **HYMER** recommends that water from the boiler is not used as drinking water.

9.3.1 Models with waste gas vent on the right-hand side of the vehicle



- ▶ If the awning is put up and the boiler is running in gas operation, exhaust gases from the boiler can escape into the awning area. Danger of suffocation! Make sure the area is sufficiently ventilated.

9.3.2 Truma boiler

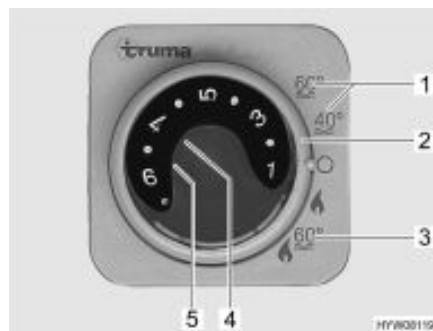

- 1 Summer operation water temperature 40 °C or 60 °C
- 2 Rotary switch
- 3 Winter operation "Heater and boiler"
- 4 Red indicator lamp "Fault" (dependent on model)
- 5 Yellow indicator lamp "Boiler heating-up phase"

Fig. 91 Operating unit for heater/boiler

The boiler is integrated into the heater and is operated with gas (gas operation) or with gas and/or electricity (gas and 240 V electrical operation). The boiler is switched on by turning the rotary switch (Fig. 91,2) on the operating unit (Fig. 91). The type of energy is pre-selected (gas and 240 V electrical operation) with the energy selector switch (Fig. 93).

In winter operation "Heater and boiler" (Fig. 91,3) the water is automatically heated up when the heater is switched on. If the heater switches off after the required room temperature has been reached, the boiler will continue to heat up until the set water temperature has been reached.

In summer operation (Fig. 91,1) only the water in the boiler is heated up to either 40 °C or 60 °C. The water is heated to 60 °C in approx. 25 minutes. The yellow indicator lamp (Fig. 91,5) illuminates during the boiler heating-up period.

The voltage supply for the boiler cannot be interrupted by an interruption to the 12 V supply on the panel. Depending on the model, the red indicator lamp (Fig. 91,4) on the operating unit lights up when there is a fault (see chapter 14).

Safety/drainage valve

The boiler is equipped with a safety/drainage valve (Fig. 92). The safety/drainage valve prevents water in the boiler from freezing, when there is frost and the heater is not switched on.



- ▷ When the vehicle is not used for a long period of time, open the safety/drainage valve and empty the boiler.
- ▷ At temperatures below 2 °C the safety/drainage valve opens automatically. Before filling the boiler, switch on the heater and wait until the temperature on the safety/drainage valve is above 6 °C. Only then can the safety/drainage valve be closed once again.
- ▷ The water pump and the water fittings are not protected against freezing by the safety/drainage valve.



- ▷ The drainage neck of the safety/drainage valve has to be free of dirt (e.g. leaves, ice) at all times.



Fig. 92 Safety/drainage valve of the boiler

Position See chapter 10, "Position of the drain cocks and safety/drainage valve" for the position of the safety/drainage valve.

Variant: Boiler with gas operation The boiler is operated exclusively with gas.

Winter operation In the "heater and boiler" switch setting in winter operation, the boiler is already switched on.

Summer operation In summer operation the water can be heated up to 40 °C or 60 °C.

- Switching on:*
- Open the regulator tap on the gas bottle and the gas isolator tap "Heater/boiler".
 - Set the rotary switch (Fig. 91,2) on the operating unit (Fig. 91) to "Summer operation" (Fig. 91,1).

The yellow indicator lamp (Fig. 91,5) is illuminated during the heating up period. When the set water temperature is reached, the period of heating up is finished and the yellow indicator lamp fades.

- Switching off:*
- Set the rotary switch (Fig. 91,2) on the operating unit (Fig. 91) to "○".
 - Close the gas isolator tap "Heater/boiler" and the regulator tap on the gas bottle.

Variant: Boiler with gas and 240 V electrical operation



- ▷ 240 V electrical operation is only possible when the vehicle is connected to the 240 V power supply.
- ▷ Select the output level for 240 V electrical operation so that it corresponds to the fuse protection of the 240 V connection (900 W for 3.9 A fuse, 1800 W for 7.8 A fuse).
- ▷ When the boiler on the operating unit is set to summer operation and the energy selector switch is set to mixed operation, the boiler still runs only in 240 V operation. The gas burner is not switched on.



- 1 240 V electrical operation (1800 W)
- 2 240 V electrical operation (900 W)
- 3 Gas operation
- 4 Gas and 240 V electrical operation (900 W)
- 5 Gas and 240 V electrical operation (1800 W)
- 6 Yellow indicator lamp "240 V electrical operation"

Fig. 93 Energy selector switch for heater/boiler

The boiler can be operated with different types of energy:

- Gas operation (Fig. 93,3)
- 240 V electrical operation with the output levels 900 W (Fig. 93,2) or 1800 W (Fig. 93,1)
- Gas and 240 V electrical operation (mixed operation) with the output levels 900 W (Fig. 93,4) or 1800 W (Fig. 93,5)

The combination gas operation and 240 V electrical operation reduces the heating-up time (only possible when the boiler on the operating unit (Fig. 91) is set to winter operation).

When 240 V electrical operation is selected, the yellow indicator lamp illuminates (Fig. 93,6).

Filling/emptying the boiler

The boiler can be supplied with water from the water tank.

Filling the boiler with water:

- Switch on 12 V power supply on the panel.
- Close the safety/drainage valve. Turn the knob (Fig. 92,1) perpendicular to the safety/drainage valve and push the push button (Fig. 92,2) in.
- Set all the water taps to "Hot" and open them. The water pump is turned on. The warm water pipes are filled with water.
- Keep the taps open until the water flowing out of the taps has no bubbles in it. This is the only way to ensure that the boiler is full of water.
- Close all water taps.

Emptying the boiler:

- Set the rotary switch (Fig. 91,2) on the operating unit (Fig. 91) to "○".
- Open the safety/drainage valve. To do this turn the knob (Fig. 92,1) parallel to the safety/drainage valve. The push button (Fig. 92,2) jumps out. The boiler is drained to the outside by the safety/drainage valve.
- Check whether the water has been drained completely from the boiler (approx. 12 litres).



- ▷ Further information can be obtained in the manufacturer's instruction manual.

9.3.3 Alde boiler

Switching the boiler on/off

The boiler is integrated in the hot-water heater. A separate operation is not possible. For operating the hot-water heater, see section 9.2.4.

Filling/emptying the boiler

The boiler can be supplied with water from the water tank.



Fig. 94 Drain cocks

Filling the boiler with water:

- Close drain cocks. To do so, turn the cap (Fig. 94,1) in a clockwise direction and set the rocking lever (Fig. 94,2) in a horizontal position.
- Switch on 12 V power supply on the panel.
- Set all the water taps to "Hot" and open them. The water pump is turned on. The warm water pipes are filled with water.
- Keep the taps open until the water flowing out of the taps has no bubbles in it. This is the only way to ensure that the boiler is full of water.
- Close all water taps.

Emptying the boiler:

- Switch off boiler.
- Open drain cock (Fig. 94). To do so, set the rocking lever (Fig. 94,2) in a vertical position.
- Check whether the water has been drained completely from the boiler (approx. 7-10 litres).



- ▷ For further information, see the separate manufacturer's instruction manual and observe the maintenance instructions found in chapter 12.

9.4 Cooker



- ▶ Never let gas escape unburned due to danger of explosion.
- ▶ Before using the cooker make sure that there is sufficient ventilation. Open windows or the skylight.
- ▶ Do not use gas cooker or gas oven for heating.
- ▶ Always protect your hands with cooking gloves or potholders when handling hot pots, pans and similar items. There is a risk of injury.

9.4.1 Gas cooker



- ▶ During activation and operation of the gas cooker, no flammable objects or highly inflammable objects such as dishcloths, napkins etc. must be near the gas cooker. Fire hazard!
- ▶ The process of ignition must be visible from above and must not be covered by cooking pans placed on the cooker.
- ▶ If there is a flame protection, always put it up when using the gas cooker.
- ▶ The gas cooker lid is held closed by a spring. When closing there is danger of getting injured!



- ▷ Do not use the glass gas cooker lid as a hob.
- ▷ Do not close the gas cooker lid while the gas cooker is in operation.
- ▷ Do not apply pressure on the gas cooker lid when it is closed.
- ▷ Do not place hot cooking pans on the gas cooker lid.
- ▷ Keep the gas cooker lid open after cooking until the burners are cool. Otherwise the glass plate could shatter.
- ▷ Do not place hot objects such as cooking pans on the sink cover. The plastic can become deformed.



- ▷ Only use pots and pans whose diameter is appropriate for the gas cooker burners.
- ▷ When the flame goes out, the thermocouple automatically cuts the gas supply.
- ▷ Further information can be obtained in the manufacturer's instruction manual.

The vehicle kitchen unit is fitted with a three-burner gas cooker.

Gas cooker lid A two-part gas cooker lid is fitted in the vehicle.



Fig. 95 Gas cooker lid

When using the burner on the right (Fig. 95,1) **always** also open the left gas cooker lid (Fig. 95,2).

Ignition The gas cooker is equipped with electronic ignition.



Fig. 96 Operating controls for gas cooker

- Switching on:*
- Open the regulator tap on the gas bottle and the gas isolator tap "Cooker".
 - Open the gas cooker lid.
 - If there is a flame protection, fold the flame protection out and lock it into position.
 - Turn the control knob (Fig. 96,1) on the burner you wish to use to the ignition position (large flame).
 - Press the control knob down and hold it.
 - Press the rocker switch (Fig. 96,2). Ignition sparks are generated at the burner.
 - Once the flame is burning, the control knob must be held down for 10 to 15 seconds, until the thermocouple automatically keeps the gas supply open.
 - Release the control knob and turn to the desired setting.
- Switching off:*
- Turn the control knob to the 0-position. The flame fades.
 - Close the gas isolator tap "Cooker" and the regulator tap on the gas bottle.

9.4.2 Gas oven



- ▶ Keep the ventilation openings on the gas oven open at all times.
- ▶ There must be no flammable objects near the gas oven when it is being lit.
- ▶ If ignition has not taken place, repeat the entire procedure. If necessary, check if there is gas and/or current in the gas oven.
- ▶ If the gas oven still does not work, close the gas isolator tap and notify your service centre.
- ▶ If the burner flame is accidentally extinguished, turn the control knob to "○" and leave the burner off for at least 1 minute. Then ignite it again.



- ▷ Depending on the model the gas oven may come equipped with a grill.
- ▷ Before using the gas oven for the first time run it for 30 minutes at maximum temperature without any contents.
- ▷ When the flame goes out, the thermocouple automatically cuts the gas supply.
- ▷ Further information can be obtained from the separate instruction manual "Gas oven".

The oven is equipped with electronic ignition.



Fig. 97 Gas oven (Dometic)

Switching on:

- Open the regulator tap on the gas bottle and the gas isolator tap "Oven".
- Gently press the control knob (Fig. 97,1) and turn left to any position.
- Press the control knob and hold it down for 5 to 10 seconds. Ignition will take place automatically.
- Release the control knob and turn to the desired setting.

Switching off:

- Turn control knob (Fig. 97,1) to "○". The flame fades.
- Close the gas isolator tap "Oven" and the regulator tap on the gas bottle.

9.5 Refrigerator

During the journey, only operate the refrigerator via the 12 V power supply. At high ambient temperatures the refrigerator is unable to reach its full cooling power. At high external temperatures, the full cooling power of the cooling unit is only guaranteed if the refrigerator is ventilated sufficiently. In order to achieve a better ventilation the refrigerator ventilation grill can be removed.



- ▷ When leaving the vehicle, always mount the refrigerator ventilation grill. Otherwise water can enter during rain.
- ▷ The cooling power of the refrigerator depends on the vehicle setup. The cooling power can decrease if the vehicle is inclined by 5° or more. Therefore, always park the vehicle on level ground.
- ▷ Absorption refrigerators operate at normal room temperature (approx. 21 °C) within the specified temperature range. At significantly higher ambient temperatures (> 30 °C), the cooling power is reduced. This is because the "evaporating temperature" of the refrigerant is lower in absorption refrigerators than it is in compressor refrigerators.

9.5.1 Refrigerator ventilation grill



Fig. 98 Refrigerator ventilation grill (with sliding trap)

- Removal:*
- Push sliding trap (Fig. 98,1) upward.
 - Remove refrigerator ventilation grill.

9.5.2 Operation (Dometic 7 series with automatic power selection and frame heater)

Operating modes

The refrigerator is equipped with automatic power selection (AES). The AES automatically selects the optimal energy source and regulates the refrigerator operation. Manual intervention to select the type of power is possible but not required.

The AES selects from the following types of power:

- Solar installation 12 V
- 240 V AC
- 12 V DC
- Gas

Choosing the available energy source highest on the list.



- ▷ Even when the 12 V power supply is switched off, a small electrical power flows which puts an extra load on the living area battery. Always switch off the refrigerator for a temporary lay-up.

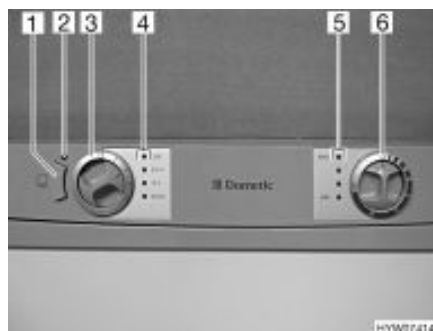

- 1 Frame heater (FH) button
- 2 Indicator lamp
- 3 Energy selector switch
- 4 Indicator lamps
- 5 Indicator lamps
- 6 Control knob for setting the temperature

Fig. 99 Operating controls for the refrigerator (Dometic 7 series with AES and FH)

240 V operation

If the 240 V power supply is connected, this energy source is selected as the first priority by the AES.

12 V operation

12 V operation is only selected by the AES if the vehicle's engine is running and the alternator supplies sufficient 12 V operating power.

Gas operation



- ▶ Never let gas escape unburned due to danger of explosion.
- ▶ It is not permitted to operate the refrigerator with car gas.



- ▷ Open the regulator tap on the gas bottle and the gas isolator tap "Refrigerator".

If the 240 V power supply is **not** connected and the vehicle's engine is **not running** the AES selects the gas supply. When selecting gas operation the ignition fuse is opened automatically so gas can get into the burner. At the same time the electronic ignition is activated. If the gas flame is extinguished, e.g. by blast of wind, the ignition is activated immediately and re-ignites the gas. When the gas operation is faulty, the "GAS" indicator lamp (Fig. 99,4) flashes red.

Change-over between energy sources



- ▶ Open flames are prohibited at petrol stations. If the stop takes longer than 15 minutes, the refrigerator has to be turned off at the energy selector switch.

When changing over between the different power sources there are forced delays built in the AES. This means, that after a change-over to a new energy source the refrigerator can not be operated immediately. When changing over from 12 V operation to gas operation, a 15-minute delay is built in the AES. This prevents a change-over to gas operation when the vehicle is stopped briefly and the engine is switched off (e.g. stop to fill tank).

Refrigerating temperature control

When turned on the first time the refrigerator automatically selects the middle thermostat position. This position can be adjusted manually by using the control knob (Fig. 99,6). The indicator lamps (Fig. 99,5) show the selected thermostat position. The refrigerating temperature for the three types of energy is set with the control knob. It takes a few hours till the refrigerator reaches its

normal operating temperature. When changing over the operating mode the thermostat setting will be maintained. The refrigerating temperature is retained regardless of the type of power being used.

Frame heater (FH)



- ▷ If the frame heater is switched on, it will always consume current. Therefore, switch off the frame heater if the vehicle engine is off and the vehicle is not connected to the 240 V power supply.

High external temperatures and high humidity can cause drops of water to form on the metal frame of the freezer compartment. This is why the refrigerator is equipped with a frame heater for the freezer compartment. If the temperature and humidity are high, switch on the frame heater by pressing the button (Fig. 99,1). This prevents corrosion. If the frame heater is switched on, the indicator lamp (Fig. 99,2) will be lit.

Manual operation

Switching on:

- Open the regulator tap on the gas bottle and the gas isolator tap "Refrigerator".
- Select the energy type with the energy selector switch (Fig. 99,3). The respective indicator lamp (Fig. 99,4) lights up green.
- Adjust refrigerating temperature with the control knob (Fig. 99,6). The indicator lamps (Fig. 99,5) show the selected thermostat position.

When the gas operation is faulty, the "GAS" indicator lamp (Fig. 99,4) flashes red.

When operated with 12 V, the refrigerator draws power only from the living area battery.



- ▷ If the refrigerator is manually set to "12 V", it will constantly consume current. Therefore, switch over to gas operation when the vehicle engine is **not** running, and the vehicle is **not** connected to the 240 V power supply.

Switching off:

- Turn the energy selector switch (Fig. 99,3) to "○". No indicator lamp (Fig. 99,4) is lit.
- Close the gas isolator tap "Refrigerator" and the regulator tap on the gas bottle.



- ▷ Further information can be obtained from the separate instruction manual "Refrigerator".

9.5.3 Operation (Dometic 8 series with manual power selection MES)

Operating modes

The refrigerator has 2 operating modes:

- Gas operation
- Electrical operation (240 V AC or 12 V DC)

The operating mode is set with the operating controls on the refrigerator panel.



- ▷ Select only one energy source.
- ▷ Even when the 12 V power supply is switched off, a small electrical power flows which puts an extra load on the living area battery. Always switch off the refrigerator for a temporary lay-up.

Gas operation



- ▶ Never let gas escape unburned due to danger of explosion.

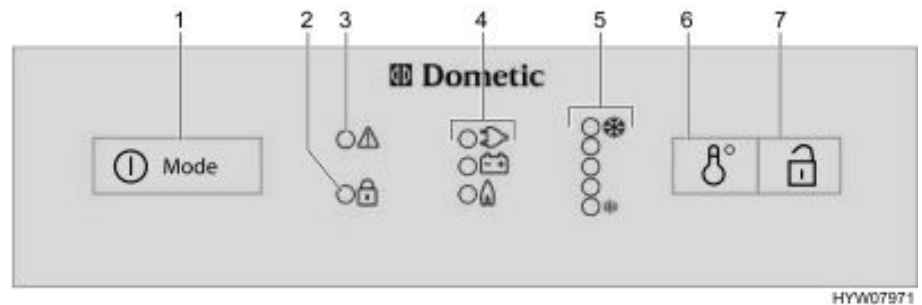

Fig. 100 Operating controls for the refrigerator (Dometic 8 series with MES)

- 1 On/off switch/energy selector switch
- 2 Display-LED "open door" (only for central locking system of the refrigerator door)
- 3 Display-LED "fault"
- 4 Operating indicators
- 5 Display-LED "temperature range"
- 6 Switch for temperature setting
- 7 Door opener (only for refrigerator door central locking system)

Switching on:

- Open the regulator tap on the gas bottle and the gas isolator tap "Refrigerator".
- Press the on/off switch/energy selector switch (Fig. 100,1) down for 2 seconds in order to switch on the appliance. The LED of the operating mode chosen most recently lights up.
- If appropriate press the on/off switch/energy selector switch (Fig. 100,1) until the gas operating indicator "🔥" lights up. Gas supply is open. Ignition will take place automatically. A ticking sound can be heard until ignition has been completed successfully.
- Use switch (Fig. 100,6) to adjust refrigerating temperature.

Switching off:

- Press down the on/off switch/energy selector switch for 2 seconds. Refrigerator is switched off.
- Close the gas isolator tap "Refrigerator" and the regulator tap on the gas bottle.

Electrical operation



- ▷ Close the gas isolator tap "Refrigerator" when the refrigerator is operated electrically.

The refrigerator can be operated with the following voltages:

- 240 V AC
- 12 V DC

- Switching the 240 V operation on:*
- Press the on/off switch/energy selector switch (Fig. 100,1) down for 2 seconds in order to switch on the appliance. The LED of the operating mode chosen most recently lights up.
 - If appropriate press the on/off switch/energy selector switch (Fig. 100,1) several times until the operating indicator 240 V "☰" lights up.
 - Use switch (Fig. 100,6) to adjust refrigerating temperature.
- Switching the 240 V operation off:*
- Press down the on/off switch/energy selector switch for 2 seconds. Refrigerator is switched off.
- Switching the 12 V operation on:*
- Press the on/off switch/energy selector switch (Fig. 100,1) down for 2 seconds in order to switch on the appliance. The LED of the operating mode chosen most recently lights up.
 - If appropriate press the on/off switch/energy selector switch (Fig. 100,1) several times until the operating indicator 12 V "☰" lights up.
 - Use switch (Fig. 100,6) to adjust refrigerating temperature.
- Switching the 12 V operation off:*
- Press down the on/off switch/energy selector switch for 2 seconds. Refrigerator is switched off.

When operated with 12 V, the refrigerator draws power only from the starter battery of the vehicle. The starter battery only supplies the refrigerator with 12 V when the vehicle engine is running. When the vehicle engine is not running, the refrigerator is cut off from the power supply in the living area. For this reason, change over to gas operation during prolonged driving breaks.



▷ Further information can be obtained from the separate instruction manual "Refrigerator".

9.5.4 Operation (Dometic 8 series with automatic power selection)

Operating modes

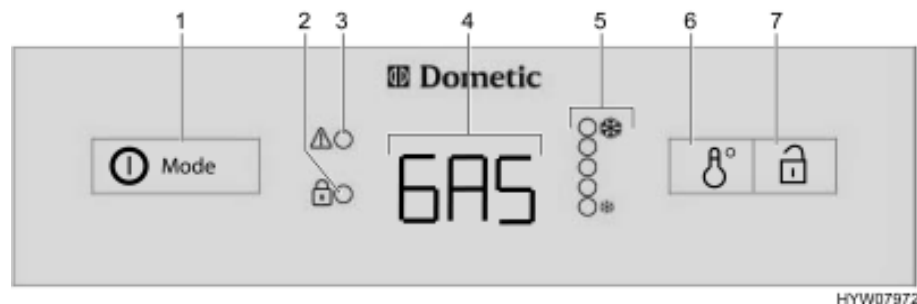

Fig. 101 Operating controls for the refrigerator (Dometic 8 series with AES)

- 1 On/off switch/energy selector switch
- 2 Display-LED "open door" (only for central locking system of the refrigerator door)
- 3 Display-LED "fault"
- 4 Operating indicator
- 5 Display-LED "temperature range"
- 6 Switch for temperature setting
- 7 Door opener (only for refrigerator door central locking system)

The refrigerator is equipped with automatic power selection (AES). If automatic operation (AU) is selected, the AES automatically selects the optimum energy source and regulates the refrigerator operation. Manual intervention to select the type of power is possible but not required.

The AES selects from the following types of power:

- Solar installation 12 V
- 240 V AC
- 12 V DC
- Gas

Choosing the available energy source highest on the list.

In the case of a fault, the LED display fault will flash "⚠" (Fig. 101,3).



- ▷ Even when the 12 V power supply is switched off, a small electrical power flows which puts an extra load on the living area battery. Always switch off the refrigerator for a temporary lay-up.

240 V operation

If the 240 V power supply is connected, this energy source is selected as the first priority by the AES.

12 V operation

12 V operation is only selected by the AES if the vehicle's engine is running and the alternator supplies sufficient 12 V operating power.

Gas operation



- ▶ Never let gas escape unburned due to danger of explosion.



- ▷ Open the regulator tap on the gas bottle and the gas isolator tap "Refrigerator".

If the 240 V power supply is **not** connected and the vehicle's engine is **not running** the AES selects the gas supply. When selecting gas operation the ignition fuse is opened automatically so gas can get into the burner. At the same time the electronic ignition is activated. If the gas flame is extinguished, e.g. by blast of wind, the ignition is activated immediately and re-ignites the gas. In the case of a fault in gas operation the text "GAS" flashes in the operating indicator (Fig. 101,4).

Change-over between energy sources



- ▶ Open flames are prohibited at petrol stations. If the stop takes longer than 15 minutes, the refrigerator has to be turned off at the energy selector switch.

When changing over between the different power sources there are forced delays built in the AES. This means, that after a change-over to a new energy source the refrigerator can not be operated immediately. When changing over from 12 V operation to gas operation, a 15-minute delay is built in the AES. This prevents a change-over to gas operation when the vehicle is stopped briefly and the engine is switched off (e.g. stop to fill tank).

Refrigerating temperature control

When turned on the first time the refrigerator automatically selects the middle thermostat position. This position can be adjusted manually by using the switch for temperature setting (Fig. 101,6). The indicator LEDs (Fig. 101,5) show the selected thermostat position. The refrigerating temperature for the three types of energy is set with the switch. It takes a few hours till the refrig-

erator reaches its normal operating temperature. When changing over the operating mode the thermostat setting will be maintained. The refrigerating temperature is retained regardless of the type of power being used.

Manual operation

- Switching on:*
- Open the regulator tap on the gas bottle and the gas isolator tap "Refrigerator".
 - Press the on/off switch/energy selector switch (Fig. 101,1) down for 2 seconds in order to switch on the appliance. The operating mode selected most recently is shown in the operating indicator (Fig. 101,4).
 - Select the energy type with the on/off switch/energy selector switch (Fig. 101,1).
 - Set the refrigerating temperature on the switch for temperature setting (Fig. 101,6). The indicator LEDs (Fig. 101,5) show the selected thermostat position.

When operated with 12 V, the refrigerator draws power only from the living area battery.



- ▷ If the refrigerator is manually set to "12 V", it will constantly consume current. Therefore, switch over to gas operation when the vehicle engine is **not** running, and the vehicle is **not** connected to the 240 V power supply.

- Switching off:*
- Press down the on/off switch/energy selector switch (Fig. 101,1) for 2 seconds. All displays close.
 - Close the gas isolator tap "Refrigerator" and the regulator tap on the gas bottle.



- ▷ Further information can be obtained from the separate instruction manual "Refrigerator".

9.5.5 Refrigerator door locking mechanism

With some models, the refrigerator has a separate freezer compartment. The specifications in this section correspondingly also apply to the door of the freezer compartment.



- ▷ During the journey the refrigerator door must always be closed and locked in the closed position.



- ▷ Lock the refrigerator door in ventilation position when the refrigerator is switched off. This prevents mould forming.

There are two positions for locking the refrigerator door in place:

- Closed refrigerator door during travel and when the refrigerator is in operation
- Slightly opened refrigerator door as a ventilation position when the refrigerator is switched off

Dometic 7 series with separate freezer compartment

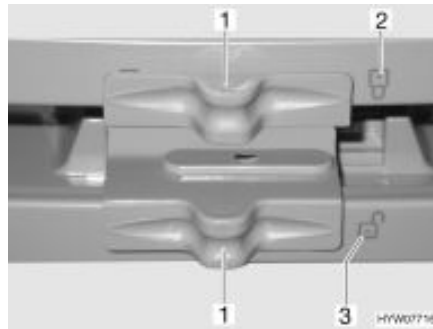

Fig. 102 Locking of the refrigerator door/freezer compartment door (Dometic 7 series with separate freezer compartment)



Fig. 103 Refrigerator door/freezer compartment door in ventilation position (Dometic 7 series with separate freezer compartment)

Opening:

- Push the lock (Fig. 102,1) to the side, so that the open lock "🔓" (Fig. 102,3) is completely visible.
- Use recessed grip to open refrigerator door/freezer compartment door.

Closing:

- Fully close the refrigerator door/freezer compartment door.
- Push the lock (Fig. 102,1) to the side, so that the closed lock "🔒" (Fig. 102,2) is completely visible.

Locking in the ventilation position:

- Slightly open refrigerator door/freezer compartment door.
- Push the lock completely to the right. The door latch (Fig. 103,1) keeps the refrigerator door/freezer compartment door in a fixed position. The refrigerator door/freezer compartment door will then stay slightly open (Fig. 103).

Dometic 8 series



Fig. 104 Release button of the refrigerator door (Dometic 8 series)



Fig. 105 Lock hook fixture

Opening:

- Press the release button (Fig. 104,1) and open the refrigerator door.

Closing:

- Close the refrigerator door. The lock hook engages audibly.

When the vehicle has been positioned, the lock hook can be fixed. The refrigerator door can now be opened without having to press the release button.

Fixing the lock hook:

- Press the fixture (Fig. 105,1) upwards. The lock hook (Fig. 105,2) is pressed upwards and has no function.

Unlocking the lock hook: ■ Push the lock hook (Fig. 105,2) down. The lock hook functions again.

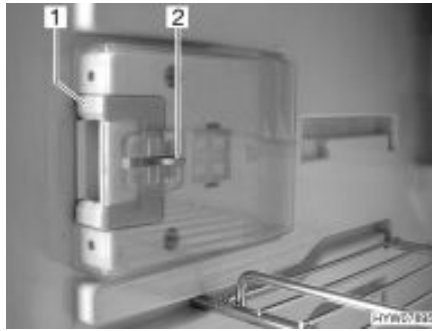

Fig. 106 Locking device in normal position

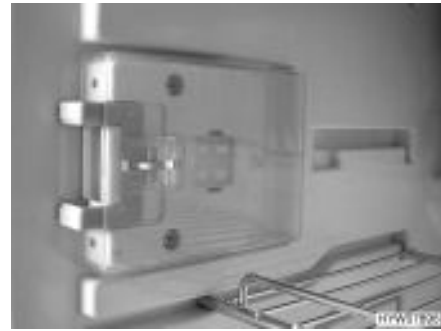

Fig. 107 Locking device in ventilation position

Locking in the ventilation position:

- Open the refrigerator door.
- Press down the unlocking device (Fig. 106,2).
- Push locking device (Fig. 106,1) forwards (Fig. 107).

If the refrigerator door is closed now, a gap will remain between the refrigerator door and the refrigerator.

Chapter overview

This chapter contains instructions regarding the sanitary fittings of the vehicle. The instructions address the following topics:

- water tank
- waste water tank
- complete water system
- toilet compartment
- toilet

The positions of the safety/drainage valve (Truma) and the drain cocks in the vehicle are specified the notes at the end of this chapter.

10.1 Water supply, general



- ▶ Fill water tank from supply systems that have been verified to provide drinking water quality.
- ▶ Only use such hoses or containers when filling that have been approved for use with drinking water.
- ▶ Thoroughly rinse filling hose or container with drinking water before use (2 to 3 times capacity).
- ▶ Empty filling hose or container completely after use and close openings of the filling hose or container.
- ▶ Water left standing in the water tank or in the water pipes becomes undrinkable after a short period. Therefore, before each use of the vehicle, thoroughly clean the water pipes and the water tank. After each use of the vehicle completely empty the water tank and the water pipes.
- ▶ In the case of lay-ups lasting more than a week disinfect the water system before using the vehicle.



- ▷ If the vehicle is not used for several days or if it is not heated when there is a risk of frost, empty the entire water system. Leave the water taps on in central position. Leave the safety/drainage valve (Truma) and all drain cocks open. Frost damage to appliances, frost damage to the vehicle and deposits in water-carrying components can be avoided in this way.
- ▷ The water pump will overheat without water and can get damaged. Never operate water pump when the water tank is empty.

The vehicle is equipped with a fitted water tank. An electric water pump pumps the water to the individual water taps. Opening a water tap automatically switches on the water pump and pumps water to the tap.

The waste water tank collects the waste water. The water level in the water and waste water tanks can be checked on the panel.



- ▷ Before the water fittings can be used, the 12 V power supply on the panel must be switched on. Otherwise the water pump will not work.
- ▷ When the water tank is re-filled, an air bubble may form at the bottom of the pump. This air bubble will prevent water from being drawn in. Shake the water pump up and down energetically in the water.

10.2 Water tank

The water tank holds up to 130 l. However, an overflow has been installed in the water tank which limits the volume to 20 l for safety reasons.



- ▷ The panel has not been adjusted to this limited volume. The level indicator on the panel shows the actual level of the water tank (e.g. "25 %" if filled to the overflow).

If necessary or if there is a sufficiently large residual vehicle payload, the water tank can be filled up to its actual capacity. Close the overflow (see section 10.2.3).

10.2.1 Drinking water filler neck with flap



- ▶ The cap for the fuel filler neck and for the drinking water filler neck are very similar. Before filling the tank, always check the label.



Fig. 108 Cap for the drinking water filler neck

The drinking water filler neck is on the right or left side of the vehicle, depending on the model.

The drinking water filler neck is marked by the symbol .

Opening:

- Swing the external flap (Fig. 108,1) upwards.
- Insert key into locking cylinder and turn a quarter turn. The cap is unlocked.
- Remove the key.
- Turn blue cap (Fig. 108,2) one quarter turn.
- Remove cap.
- Fill the water tank with drinking water. Use a water hose, a water canister with a funnel or similar for filling.

Closing:

- Place the cap on the drinking water filler neck.
- Turn the cap one quarter turn.
- Insert key into locking cylinder and turn a quarter turn. The cap is locked.
- Remove the key.
- Check that the cap sits firmly on the drinking water filler neck.
- Swivel external flap downwards and close it.

10.2.2 Filling with water



▶ When filling the water tank, observe the maximum permissible gross weight of the vehicle. Luggage must be reduced accordingly when the water tank is full.

- Open drinking water filler neck.
- Fill the water tank with drinking water. Use a water hose, a water canister with a funnel or similar for filling.
- Close drinking water filler neck.

10.2.3 Closing/opening the safety overflow



▶ When filling the water tank, observe the maximum permissible gross weight of the vehicle. Luggage must be reduced accordingly when the water tank is full.

Handle The handle is installed on the water tank.



Fig. 109 Water tank with handle

- Closing:*
- Turn the handle (Fig. 109,1) on the water tank in a clockwise direction as far as it will go.
 - Fill the water tank with drinking water.
- Opening:*
- Turn the handle (Fig. 109,1) on the water tank in an anticlockwise direction as far as it will go. Excess water will drain away leaving 20 litres in the tank.

10.2.4 Draining water (handle with safety overflow)



Fig. 110 Water tank with handle

- Turn the handle (Fig. 110,1) on the water tank in an anticlockwise direction as far as possible beyond the resistance to fully open the drainage opening.

10.3 Waste water tank

Hot air from the living area heater heats the waste water tank. This protects the waste water tank from frost.



- ▷ If the living area heater is out of order, the waste water tank no longer is sufficiently protected against frost. If there is a risk of frost, empty the waste water tank and leave the drain cock open.
- ▷ Never pour boiling water directly into the sink outlet. Boiling water could cause deformation and leaks in the waste water pipe system.



- ▷ Only empty the waste water tank at disposal stations, camping sites or caravan sites especially provided for this purpose.

Waste water from the kitchen and washing unit flows through plastic pipes into the waste water tank.

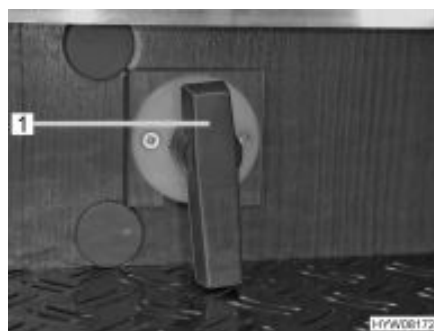

Fig. 111 Operating lever of the waste water tank

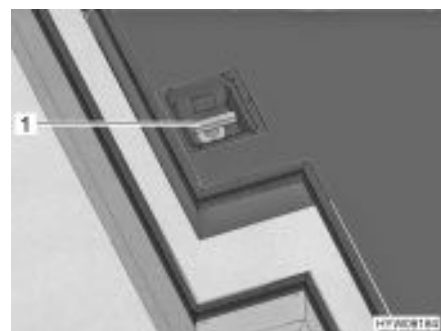

Fig. 112 Operating lever of the waste water tank (alternative)

Position for operating lever

The operating lever for waste water disposal is located in the rear garage. The drain pipe with a connection for a waste water hose is located under the vehicle.

- Emptying:*
- Attach the waste water hose to the drain pipe.
 - Open drain cock. To do this, turn the operating lever (Fig. 111,1) of the drain cock one quarter turn. The operating lever is in a vertical position or along to the drain pipe. The waste water will run out.
 - Completely empty waste water tank.
 - Close the drain cock again once all of the waste water has run out. To do this, turn the operating lever (Fig. 111,1) of the drain cock one quarter turn. The operating lever is in a horizontal position or at right angles to the drain pipe.
 - Remove the waste water hose.

10.4 Filling the water system



- ▶ When filling the water tank, observe the maximum permissible gross weight of the vehicle. Luggage must be reduced accordingly when the water tank is full.



- ▷ The water pump will overheat without water and can get damaged. Never operate water pump when the water tank is empty.



- ▷ The water quantity can be monitored on the panel while the water tank is filled.

- Position the vehicle horizontally.
- Switch on 12 V power supply on the panel.
- Close the safety/drainage valve (Truma). Turn the knob perpendicular to the safety/drainage valve and press the push button in.
If the temperature is below 6 °C, the safety/drainage valve cannot be closed. Therefore switch on the living area heater and wait until the temperature of the safety/drainage valve exceeds 6 °C.
- Close drain cocks. To do so, close the caps by turning them in a clockwise direction and set the rocking lever in a horizontal position. The position of the safety/drainage valve and the drain cocks is specified in the section on "Position of the drain cocks and safety/drainage valve" at the end of this chapter.
- Close all water taps.
- Close drainage opening on the water tank.
- Open the drinking water filler neck on the outside of the vehicle.
- Fill the water tank with drinking water. Use a water hose, a water canister with a funnel or similar for filling.
- Set all the water taps to "Hot" and open them. The water pump is turned on. The warm water pipes are filled with water.
- Keep the taps open until the water flowing out of the taps has no bubbles in it. This is the only way to ensure that the boiler is full of water.
- Set all water taps to "Cold" and leave them open. This will fill the cold water pipes with water.
- Keep the taps open until the water flowing out of the taps has no bubbles in it.

- Close all water taps.
- Close drinking water filler neck.
- Check that the cap on the water tank is not leaking.

10.5 Emptying the water system



- ▷ If the vehicle is not used for several days or if it is not heated when there is a risk of frost, empty the entire water system. Leave the water taps on in central position. Leave the safety/drainage valve (Truma) and all drain cocks open. Frost damage to appliances, frost damage to the vehicle and deposits in water-carrying components can be avoided in this way.



- ▷ Take note of the environmental tip in this chapter.

The position of the safety/drainage valve and the drain cocks is specified in the section on "Position of the drain cocks and safety/drainage valve" at the end of this chapter.

To empty and ventilate the water system, proceed as follows. This will avoid frost damage:

- Position the vehicle horizontally.
- Switch off 240 V power supply.
- Switch off the 12 V power supply on the panel.
- Shut off the boiler (see section 9.3).
- Open drain cocks. To do this turn the cap in an anticlockwise direction or set the rocking lever in a vertical position.
- Open the safety/drainage valve (Truma). To do this turn the knob parallel to the safety/drainage valve.
- Open the water tank drain.
- Open all water taps and set to the central position.
- Hang the shower handset up in the shower position.
- Hold the water pump up until the water pipes are completely empty.
- Check whether the water tank is completely empty.
- Blow out the remaining water in the water pipes (max. 0.5 bar). To do this, remove the water pipe from the water pump and blow into the water pipe.
- Empty the waste water tank. Take note of the environmental tips in this chapter.
- Empty the sewage tank. Take note of the environmental tips in this chapter.
- Clean the water tank and then rinse it out thoroughly.
- Let the water system dry for as long as possible.
- After emptying, leave all water taps on in the central position.
- Leave the safety/drainage valve (Truma) and all drain cocks open.

10.6 Toilet compartment



- ▷ Do not transport any loads in the shower tray. The shower tray or other items of equipment in the toilet compartment can be damaged.



- ▷ For ventilation purposes during or after a shower, and for drying wet clothing, close the toilet compartment door and open the window or the toilet compartment skylight. This improves the air circulation.
- ▷ Use the shower handset for showers. To do so, pull out the shower handset.
- ▷ Close the shower curtain completely when showering, so that no water is able to enter the area between the wash room wall and the shower tray.
- ▷ After taking a shower, rinse soap residue from the shower tray, otherwise cracks can appear in the shower tray over time.
- ▷ After using the shower, wipe it dry to prevent moisture from collecting.
- ▷ Pitch the vehicle so that it is as horizontal as possible. Otherwise, the water from the shower tray will not be able to drain properly.
- ▷ Further information about cleaning the toilet compartment can be found in the section 11.2.

10.7 Toilet



- ▷ If there is any risk of frost and the vehicle is not heated, empty the sewage tank.
- ▷ Do not sit on the lid of the toilet. The lid is not designed to bear the weight of a person and could break.
- ▷ Use a suitable chemical for this toilet. The ventilation will merely remove the odour but not germs and gases. Germs and gases will have a detrimental effect on the sealing rubbers.



- ▷ Further information can be obtained in the manufacturer's instruction manual.



- ▷ Only empty the sewage tank at disposal stations, at camping sites or caravan sites, that are especially provided for this purpose.

10.7.1 Swivel toilet

The flushing of the Thetford toilet is fed directly from the water system of the vehicle. The toilet bowl can be moved into the optimal position.

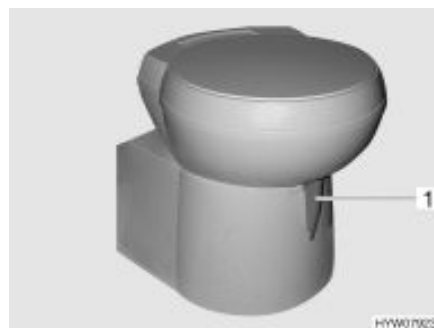

Fig. 113 Thetford toilet bowl, swivelling

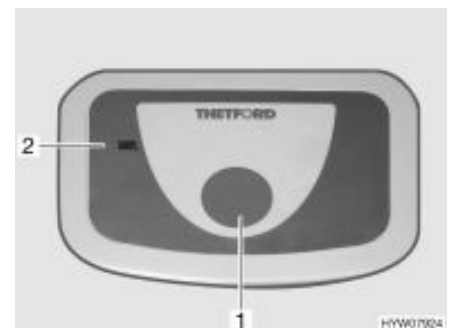

Fig. 114 Flush button/indicator lamp Thetford toilet

The operating unit is located close to the toilet bowl.

- Flushing:*
- Before flushing open the sliding trap of the Thetford toilet. To do this, push the slide lever (Fig. 113,1) in an anticlockwise direction.
 - For flushing, press the blue flush button (Fig. 114,1).
 - After flushing close the sliding trap. To do this push the slide lever in a clockwise direction.

The indicator lamp (Fig. 114,2) goes on whenever the sewage tank has to be emptied.

10.7.2 Toilet with fixed seat

The flushing of the toilet is fed from the water system of the vehicle.

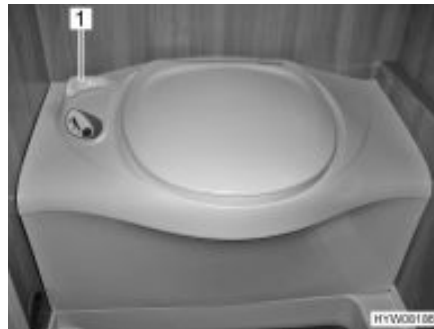

Fig. 115 Thetford toilet

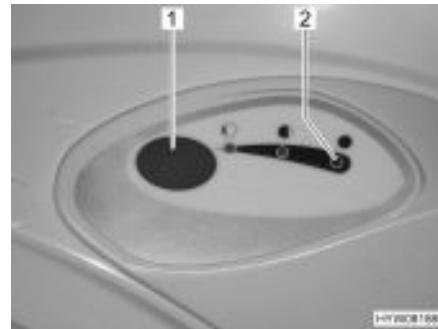

Fig. 116 Flush button/indicator lamp Thetford toilet

- Flushing:*
- Before flushing open the sliding trap of the Thetford toilet. To do this, turn the slide lever (Fig. 115,1) in an anticlockwise direction.
 - For flushing, press the blue flush button (Fig. 116,1).
 - After flushing close the sliding trap. To do this turn the slide lever (Fig. 115,1) in a clockwise direction.

The indicator lamp (Fig. 116,2) goes on whenever the sewage tank has to be emptied.

10.7.3 Emptying the sewage tank



▷ The sewage tank can only be taken out if the sliding trap is closed.

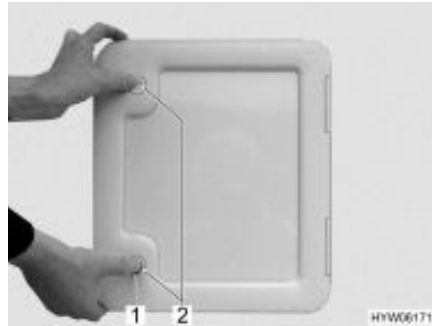

Fig. 117 Flap for the sewage tank



Fig. 118 Sewage tank

- Slide the slide lever on the toilet bowl in a clockwise direction. The sliding trap is closed.
- Open the flap for the sewage tank on the outside of the vehicle. Insert the key into the locking cylinder of the push-button lock (Fig. 117,1) and turn a quarter turn in a clockwise direction.
- Remove the key.
- Press both push-button locks (Fig. 117,2) simultaneously with your thumb and open the flap for the sewage tank.
- Pull the retaining clip (Fig. 118,1) upwards and pull out the sewage tank (Fig. 118,2).
- Remove the water tank extension to ensure it does not get lost when emptying.
- Completely empty the sewage tank at disposal stations that are especially provided for this purpose.



▷ Actuate the aeration knob on the sewage tank with your thumb to empty it completely.

10.7.4 Winter operation



▷ Do not use antifreeze. Antifreeze can damage the toilet.

If the toilet, the water tank and the sewage tank are in a frost-protected part of the vehicle, the toilet can also be used in the winter.

If the toilet, the water tank and the sewage tank are not in a frost-protected part of the vehicle, empty the water tank, the sewage tank and the water pipes if there is a risk of frost. This prevents frost damage.

10.7.5 Temporary lay-up



- ▷ If the toilet is not to be used for an extended period, empty the water tank, the sewage tank and the water pipes.

Laying up the toilet:

- Empty the water tank.
- Flush the toilet until no more water runs into the toilet.
- Empty the sewage tank.
- Rinse the sewage tank thoroughly.
- Leave the drainage neck on the sewage tank open.
- Let the sewage tank dry for as long as possible.

10.8 Position of the drain cocks and safety/drainage valve

The drain cock and the safety/drainage valve (Truma) are fitted under the L-seat group in all models. The drain cock and the safety/drainage valve are accessible via an external flap on the side of the vehicle.

Chapter overview

This chapter contains instructions regarding the care of the vehicle.

The instructions address the following topics:

- exterior of the vehicle
- interior
- cushions
- water system
- winter operation

At the end of the chapter there is a checklist of measures you must carry out if you are not going to use the vehicle for an extended period of time.

The checklist address the following topics:

- temporary lay-up
- winter lay-up
- start-up after a lay-up

11.1 External care

11.1.1 General

Standard external care consists of regular washing. The use and the environmental conditions will determine how often the vehicle needs to be washed. Wash the vehicle more frequently in areas which are exposed to heavy air pollution or heavy traffic or roads treated with de-icing salts. If the vehicle is exposed to salty and humid air (coastal areas, humid climates), wash the vehicle more frequently.

Do not park under trees if at all possible. The resin-like discharge which many trees secrete, give the paintwork a matt look and can promote the onset of corrosion.

Wash off bird droppings straight away and thoroughly, as the acid it contains is extremely corrosive.

11.1.2 Washing with a high-pressure cleaner



- ▷ Do not clean the tyres with a high-pressure cleaner. The tyres might be damaged.
- ▷ Do not spray external applications (deco-films) directly with the high-pressure cleaner. The external applications could come off.

Before cleaning the vehicle with a high-pressure cleaner, observe the operating instructions of the high-pressure cleaner.

When cleaning with the nozzle for circular jet between the vehicle and the cleaning nozzle, maintain a minimum distance of approx. 700 mm.

Take into consideration that the jet of water comes out of the cleaning nozzle with pressure. The vehicle may be damaged by incorrect handling of the high-pressure cleaner. The temperature of the water should not be above 60 °C. Keep the jet of water in constant movement during the washing process. Do not direct the water jet at clearances, built-in electrical parts, plugs, seals, the ventilation grill or the skylights. The vehicle may be damaged or water may enter the interior.

11.1.3 Washing the vehicle



- ▷ Never clean the vehicle in the car wash. Water can enter the refrigerator grills, the waste gas vents, the ventilation of the extractor hoods or the forced ventilations. The vehicle could be damaged.
- Wash the vehicle only on a washing site intended for this purpose. Avoid full sunshine. Observe environmental measures.
- Only clean external applications and synthetic parts with plenty of warm water, dish washing liquid and soft cloth.
- Wash down the vehicle with plenty of water, a clean sponge or a soft brush. In the case of stubborn dirt add dish washing liquid to the water.
- Painted exterior walls may also be cleaned with a caravan cleaner.
- Treat rubber seals of doors and storage flaps with talc.
- Treat locking cylinder of doors and storage flaps with graphite dust.

11.1.4 Windows of acrylic glass



Acrylic glass windows are delicate and require very careful handling.

- ▷ Never rub acrylic glass windows dry as dust particles might damage the surface!
- ▷ Only clean acrylic glass windows with plenty of warm water, some dish washing liquid and a soft cloth.
- ▷ Never use glass cleaning agents with chemical, abrasive or alcohol-containing additives. Premature brittleness of the panes and associated cracks may result from their use.
- ▷ Avoid contact of cleansing agents used for the body (e.g. tar- or silicone-removing agents) with acrylic glass.
- ▷ Do not clean vehicle in car wash.
- ▷ Do not attach stickers to the acrylic glass windows.
- ▷ Having cleaned the vehicle rinse acrylic glass with sufficient clear water.
- ▷ Apply talcum powder to rubber seals.
- ▷ An acrylic glass cleanser with antistatic effect is suitable for a follow-up treatment. Small scratches can be treated with an acrylic glass polish. These agents are available at the accessories shop.



11.1.5 Add-on parts made of glass-fibre reinforced plastic (GRP)



- ▷ Avoid contact between polish and window rubber and piping.
- ▷ The glass-fibre reinforced plastic (GRP) may not become too hot. Therefore when polishing with a polishing machine, keep the machine in constant motion.

GRP add-on parts can turn yellow or become weather-worn due to insufficient care for the vehicle or ageing of the material.

GRP add-on parts should therefore undergo regular follow-up treatment. This way, these parts will not turn yellow and the sealing of the surface remains intact.

Follow-up treatment of GRP add-on parts:

- Wash the vehicle and allow to dry as described above. Check if the GRP add-on parts are clean and dry.
- Apply the polisher with a soft cloth evenly on the surface of the GRP add-on part.
- Wait until a light grey film forms.
- Wipe the GRP add-on part with a dry, soft cloth. Move the cloth in circles over the surface of the GRP add-on part.

We recommend using a polishing machine for this work.



- ▷ Paint protection has to be used to preserve the polish. Please read the instructions of the paint protection for details on how to apply it.

11.1.6 Underbody

The underbody of the vehicle is partly coated with an age-resistant underbody protection. Should the underbody protection be damaged, repair immediately. Do not treat areas coated with underbody protection with spray oil.



- ▷ Only use products approved by the manufacturer. Our authorised dealers and service centres will be happy to advise you.

11.1.7 Waste water tank

Clean the waste water tank after every use.

Cleaning:

- Empty the waste water tank.
- Open the cleaning opening on the waste water tank and the drain cock.
- Thoroughly rinse out the waste water tank with fresh water.
- If possible, clean waste water sensors through the cleaning opening by hand.

11.1.8 Entrance step

If the entrance step is lubricated, coarse particles of dirt can settle on the lubricant during the journey and cause damage to the operating mechanism of the entrance step. Therefore, do not lubricate the moving parts of the entrance step.

11.2 Interior care



- ▷ If possible, treat stains immediately.
- ▷ Acrylic glass windows are delicate and require very careful handling (see section 11.1.4).
- ▷ Synthetic parts in the toilet and living area are very delicate and should be treated with care. Do not use solvents, alcohol-containing cleansers or scourers containing sand. This procedure will help you to avoid brittleness and formation of cracks.
- ▷ Do not pour any corrosive agents into the drain holes. Never pour boiling water directly into the drain holes. Corrosive agents and boiling water cause damage to drainage pipes and siphon traps.



- ▷ Do not use vinegar based products to clean the toilet and water system, or for decalcification of the water system. Vinegar-based products may cause damage to seals or parts of the installation. Use standard decalcifying products for decalcification.
- ▷ Save water. Mop up all remaining water.



- ▷ For information about the use of maintenance products, our representatives and service centres will be glad to advise.
- Surface and knobs of furniture, lamps and synthetic parts in the toilet and living area should be cleaned with water and a wool cloth. A mild cleanser may be added to the water. If required, use furniture polish for the painted surfaces.
- Curtains and net curtains should be dry cleaned.
- Vacuum clean the carpet, if necessary clean with carpet shampoo.
- Clean PVC-floor covering with a mild, soapy cleanser for PVC floors. Do not place carpet on wet PVC-floor covering. The carpet and the PVC-floor covering may stick together.
- Never clean the sink or the gas cooker with a scourer. Avoid anything which may cause scratching or grooves.
- Clean gas cooker only with a moist cloth. Prevent any water from penetrating the gas cooker. Water may damage the gas cooker.
- Brush insect screen with a soft brush or vacuum with the brush attachment of the vacuum cleaner.
- Brush blinds with a soft brush or vacuum with the brush attachment of the vacuum cleaner. Grease or stubborn dirt may be removed with a mild soap at 30 °C (curd soap).
- Brush Roman shades with a soft brush or vacuum with the brush attachment of the vacuum cleaner. Grease or stubborn dirt may be removed with a mild soap at 30 °C (curd soap).
- Unrolled seat belts can be cleaned with warm soapsuds. The seat belt must be completely dry before being rolled up.

11.3 Cushions

The care and cleaning instructions below are for assistance only. They are not a guarantee of successful cleaning. These instructions cannot form the basis for any warranty claims.



- ▷ If possible, treat stains immediately.
- ▷ Never use household cleaners to remove marks (e.g. detergents).
- ▷ Before treating marks, test the cleaning on a hidden part of the upholstery covers. This will show you whether the cleaning will damage the materials or dyes.
- ▷ Always only dab moist or greasy marks, never rub them. It is most effective to gently press an absorbent cloth or a sponge onto the mark.
- ▷ Do not wash upholstery.
- ▷ When cleaning leather covers, make sure that the leather is not soaked through and that no water seeps through the seams of the leather covers.



- ▷ Treat the mark from the outside working inwards. This prevents the mark from spreading.
- ▷ In the case of both solid or softer contamination, first remove the coarse parts. Next, carefully scrape off the mark with a blunt knife or spatula.
- ▷ If the mark has already dried in, carefully brush off the coarse parts. Next, dab off the mark with a damp cloth or sponge.
- ▷ The upholstery will fade over time, if it is exposed to sunlight. If the temperature within the vehicle rises rapidly as well, the colour will change at an accelerated rate.
Therefore, we recommend to close the shades on the windows when there is strong sunlight. Ensure that heat does not build up when you close the blind.

Grease, oil, wine, milk, non-alcoholic beverages

Use only ordinary water-based cleaning agents. Alternatively, mix 2 table-spoons of ammoniac with 1 litre of water. Gently dab the mark with a cloth moistened with this solution. Turn the cloth frequently so that the mark only comes into contact with a clean part of the cloth.

Urine, sweat

Use only ordinary water-based cleaning agents. Alternatively, mix 2 table-spoons of ammoniac with 1 litre of water. Gently dab the mark with a cloth moistened with this solution. Turn the cloth frequently so that the mark only comes into contact with a clean part of the cloth.

Chocolate, coffee

Dab with lukewarm water.

Fruits

Dab with cold water.

Wax, candle

Carefully scrape off the wax with a blunt knife or spatula. Cover the mark with several layers of waterleaf paper and iron.

Blood

Mix 2 tablespoons of salt and 1 litre of water. Moisten the mark and dab with a dry cloth. Dab stubborn marks with ammonia solution.

Ballpen, ink

Gently dab the mark with a cloth moistened with cleaner's naphtha. Turn the cloth frequently so that the mark only comes into contact with a clean part of the cloth.

Mud

Carefully remove as much mud as possible with a blunt knife or a spatula. Allow the mud to dry and then remove it with a vacuum cleaner. For stubborn marks, use only ordinary water-based cleaning agents. Alternatively, mix 2 tablespoons of ammonia solution with 1 litre of water. Gently dab the mark with a cloth moistened with this solution. Turn the cloth frequently so that the mark only comes into contact with a clean part of the cloth.

Pencil

Use only mild, water-free and clean textile cleaning agents. Moisten a cloth with the agent. Gently dab the mark with a cloth moistened with this solution. Turn the cloth frequently so that the mark only comes into contact with a clean part of the cloth.

Vomit

Carefully clean up the vomit and wash it out with cold water. Use only ordinary water-based cleaning agents. Alternatively, mix 2 tablespoons of ammoniac with 1 litre of water. Gently dab the mark with a cloth moistened with this solution. Turn the cloth frequently so that the mark only comes into contact with a clean part of the cloth.

11.4 Water system

11.4.1 Cleaning the water tank

- Empty the water tank and close the drainage opening.
- Remove the cap of the water tank.
- Fill water tank with water and some washing-up liquid (do not use any scourers).
- Using a trade standard brush for washing dishes, scrub the water tank until there is no longer any visible deposit.
- Scrub also the pump housing.
- If possible, clean fresh water sensors through the cleaning openings by hand.
- Rinse water tank with copious amounts of drinking water.

11.4.2 Cleaning the water pipes



- ▷ Only use suitable cleaning agents as sold by the specialist trade.



- ▷ Collect any emerging mixture of water and cleaning agent for correct disposal.

- Empty the water system.
- Close all drain holes and drain cocks.
- Fill mixture of water and cleaning agent into the water tank. Observe the manufacturer's instructions regarding the mixing ratio.
- Open the drain cocks one by one.
- Leave the drain cocks open until the mixture of water and cleaning agent has reached the respective drain.
- Close the drain cocks.
- Set all the water taps to "Hot" and open them.
- Leave the water taps open until the mixture of water and cleaning agent has reached the drain.
- Set all water taps to "Cold" and open them.
- Leave the water taps open until the mixture of water and cleaning agent has reached the drain.
- Close all water taps.
- Flush the toilet several times.
- Allow the cleaning agent to act in accordance with the manufacturer's instructions.
- Empty the water system. Collect the mixture of water and cleaning agent for correct disposal.
- For rinsing fill the entire water system with drinking water and empty again several times over.

11.4.3 Disinfecting the water system



- ▷ Only use suitable disinfectants as sold by the specialist trade.



- ▷ Collect any emerging mixture of water and disinfectant for correct disposal.

- Empty the water system.
- Close all drain holes and drain cocks.
- Fill mixture of water and disinfectant into the water tank. Observe the manufacturer's instructions regarding the mixing ratio.
- Open the drain cocks one by one.
- Leave the drain cocks open until the mixture of water and disinfectant has reached the respective drain.
- Close the drain cocks.
- Set all the water taps to "Hot" and open them.
- Leave the water taps open until the mixture of water and disinfectant has reached the drain.
- Set all water taps to "Cold" and open them.
- Leave the water taps open until the mixture of water and disinfectant has reached the drain.
- Close all water taps.
- Flush the toilet several times.
- Allow the disinfectant to act in accordance with the manufacturer's instructions.
- Empty the water system. Collect the mixture of water and disinfectant for correct disposal.
- For rinsing fill the entire water system with drinking water and empty again several times over.

11.5 Winter care

De-icing salt damages the underbody and the parts open to water spray. We recommend that you wash the vehicle more frequently during wintertime. Mechanical and surface treated parts and the underside are under particular strain, and should therefore be cleaned thoroughly.



- ▷ If there is any risk of frost, always run heater at a minimum of 15 °C. Switch the circulation fan (if there is one) to automatic. In the case of extreme external temperatures, the furniture flaps and doors should be left slightly open. The inflowing warm air can help prevent the freezing of water pipes, for example, and counteract the formation of condensation in the storage spaces.
- ▷ If there is any risk of frost, cover the outside surface of the windows with winter insulation mats.

11.6 Lay-up

11.6.1 Temporary lay-up



- ▶ If the vehicle has been stationary for a long period (approx. 10 months) have the braking and gas systems checked by an authorised specialist workshop.
- ▶ Take into consideration that water is undrinkable after only a short time.
- ▶ Animal damage to cables can lead to short circuits. Fire hazard!

Animals (especially mice) can cause great damage to the interior of the vehicle. This is especially true if the animal remains undisturbed in a parked vehicle.

The animals can get into the vehicle at an opportune moment and hide from view.

To keep damages from animals to a minimum or to avoid them altogether, regularly check the vehicle for damage or animal traces. This is especially important approx. 24 hours after parking the car in storage.

If animal traces are found, contact the authorised dealer or service centre. If damage to cables has occurred, they can result in short circuits. The vehicle could catch fire.

Before laying up the vehicle, go through the following checklist:

	Activities	Done
Base vehicle	Completely fill fuel tank. This prevents corrosion damage within the fuel tank system	
	Jack up vehicle so that the wheels do not bear any load, or move vehicle every 4 weeks. This prevents any pressure points from occurring on tyres and wheel bearings	
	Protect the tyres from direct exposure to the sun. Danger of formation of cracks!	
	Inflate tyres up to the recommended maximum pressure	
	Always provide for sufficient ventilation in the underbody area	
	 ▶ Humidity or lack of oxygen e.g. by covering with plastic film may cause optical irregularities to the underbody.	
	In addition observe the notes in the operating manual of the base vehicle	
Body	All vents should be sealed with the appropriate caps and all other openings (apart from forced ventilations) should also be sealed. This prevents animals (e.g. mice) from gaining entry	
	Air the interior, all storage compartments accessible from the outside, and the parking space (e.g. garage) every 3 weeks in order to prevent the occurrence of condensation and resulting mould formation	
Interior	Place upholstery in an upright position for ventilation, and cover	
	Clean refrigerator	
	Allow refrigerator and freezer compartment doors to remain slightly open	
	Search for traces of animals that have gained entry	

	Activities	Done
	Disconnect the flat screen from the mains and, if necessary, remove it from the vehicle	
Gas system	Close regulator tap on the gas bottle Close all gas isolator taps Always remove gas bottles from the gas bottle compartment, even if they are empty	
Electrical system	Fully charge living area and starter battery  ▷ Charge the battery for at least 20 hours before laying up. Disconnect the living area battery from the 12 V power supply. To do this, switch off the battery cut-off switch on the transformer/rectifier (see chapter 8)	
Water system	Empty the entire water system. Blow out the residual water from the water pipes (0.5 bar max.). Leave the water taps on in central position. Leave the safety/drainage valve (Truma) and all drain cocks open. Observe the notes in chapter 10	

11.6.2 Winter lay-up

Additional measures are required if laying up the vehicle over winter:

	Activities	Done
Base vehicle	Clean body and underbody thoroughly and spray with hot wax or protect with varnish Fill fuel tank with winter diesel Check antifreeze in the cooling water Rectify damage to the paintwork	
Body	Clean vehicle from outside thoroughly Keep the forced ventilation open Clean and grease installed supports Clean and grease all door and flap hinges Brush oil or glycerine on all locking mechanisms Rub all rubber seals with talc Use graphite dust to treat locking cylinders	
Interior	Position de-humidifiers Remove upholstery from the vehicle and store in a dry place Air the interior every 3 weeks Empty all cabinets and storage compartments, open flaps, doors and drawers Thoroughly clean the interior If there is a risk of frost, do not leave the flat screen in the vehicle	

	Activities	Done
Electrical system	Remove the starter battery and the living area battery and store them in a place protected from frost (see chapter 8) or connect the vehicle to a 240 V supply	
Water system	Clean the water system using a cleaning agent from a specialised store	
Complete vehicle	Arrange the tarpaulins in such a way that the ventilation openings are not covered, or use porous tarpaulins	

11.6.3 Starting up the vehicle after a temporary lay-up or after lay-up over winter

Go through the following checklist before start-up:

	Activities	Done
Base vehicle	Check the tyre pressure on all tyres Check the tyre pressure of the spare wheel	
Body	Clean the pivot bearing of the entrance step Check the functioning of the fitted supports Check that the doors, windows and skylights are working properly Check that all the external locks are working, such as the external flaps, the filler neck and the conversion door Remove the cover from the waste gas vent of the heater (if there is one) Remove the winter cover from the refrigerator grills (if there is one)	
Gas system	Put the gas bottles in the gas bottle compartment, tie down and connect to the gas pressure regulator	
Electrical system	Connect to 240 V power supply using the external socket Fully charge living area and starter battery  ▷ Charge the battery for at least 20 hours after lay-up. Connect the living area battery with the 12 V power supply. To do this, switch on the battery cut-off switch on the transformer/rectifier (see chapter 8) Check that the electrical system are working, e.g. interior light, socket and all installed electrical appliances	
Water system	Disinfect water pipes and water tank Check the functionality of the operating lever for the waste water tank Close safety/drainage valve (Truma), drain cocks and water taps Check water system for leaks	

Appliances

Activities	Done
Check the function of the refrigerator	
Change heating fluid of the hot-water heater every 2 years	
Check the function of the heater/boiler	
Check the function of the gas cooker	
Check the function of the air conditioning unit	
Check the function of the oven	

Chapter overview

This chapter contains instructions about inspection and maintenance work concerning the vehicle.

The maintenance instructions address the following topics:

- Alde hot-water heater
- independent vehicle heater
- replacing light bulbs
- spare parts

At the end of the chapter you will find the **HYMER** service numbers and important instructions on how to obtain spare parts.

12.1 Inspection work

Like any technical appliance, the vehicle must be inspected at regular intervals.

This inspection work must be carried out by qualified personnel.

Special technical knowledge, which cannot be taught within the framework of this instruction manual, is required for these tasks. Personnel possessing this technical knowledge are available for assistance at all service centres. Their experience and regular technical instruction by the factory as well as equipment and tools guarantee expert and up-to-date inspection of the vehicle.

The service centre in charge will confirm the work performed.

Have chassis inspections confirmed in the chassis manufacturer's customer service booklet.



- ▷ Observe the inspections indicated by the manufacturer and have them carried out at the specified intervals. The value of the vehicle is thus preserved.
- ▷ The confirmation of the inspection work carried out serves as valid proof in the event of damage and guarantee claims.

12.2 Maintenance work

As with every machine, this vehicle requires maintenance. The extent and frequency of the maintenance work required depend on conditions of operation and use. More difficult operating conditions make it necessary to service the vehicle more often.

Have the base vehicle and the appliances serviced at the intervals specified in the corresponding instruction manuals.

12.3 Alde hot-water heater



- ▷ Check the level of the heating fluid regularly on the compensator reservoir.
- ▷ During or after the first operating hours of the hot-water heater, the filling level may fall below the minimum mark. If this is the case, top up the heating fluid.
- ▷ We recommend to bleed the heating system after the initial heater operation and to check the glycol content.



- ▷ Have heating fluid changed by an authorised dealer or a service centre at intervals of approximately two years as corrosion-protection wears off after some time.
- ▷ Top up heating system with a water-glycol mixture (60 : 40) only. This mixture offers frost protection up to -25 °C. When topping up hot-water heaters that are connected to the engine's cooling circuit, please observe the instructions in the manufacturers' instruction manuals.



- ▷ Further information can be obtained in the manufacturer's instruction manual.

12.3.1 Checking the fluid level



Fig. 119 Compensator reservoir hot-water heater

- Switch off the hot-water heater and allow it to cool down.
- Check if the fluid level is between the marks "MIN" (Fig. 119,3) and "MAX" (Fig. 119,2) on the compensator reservoir (Fig. 119).

12.3.2 Topping up heating fluid

- Position the vehicle horizontally. This prevents the formation of bubbles.
- Switch off the hot-water heater and allow it to cool down.
- Unscrew or pull off the panel.
- Open the rotary lid (Fig. 119,1) on the compensator reservoir.
- Remove cover.
- Check anti-freeze with an anti-freeze hydrometer. The frost protection content must be 40 % or correspond to a frost protection of -25 °C.
- Fill water frost protection mixture slowly into the compensator reservoir.



- ▷ The optimum fluid level is reached when the fluid in the compensator reservoir is 1 cm above the "MIN" mark when it is cooled down.

12.3.3 Bleeding the heating system



Fig. 120 Bleeding valve of hot-water heater

The bleeding valves are built in nearby the radiators.

- Switch off the hot-water heater and allow it to cool down.
- Open bleeding valve (Fig. 120,1) and leave open until no more air escapes.
- Close bleeding valve.
- Repeat this procedure at all bleeding valves.
- Check to see if the hot-water heater warms up.

12.4 Independent vehicle heater

Use the independent vehicle heater for 10 minutes at least once a month with a cold engine and smallest fan settings.

Before the heating season starts, have the independent vehicle heater checked by an authorised specialist workshop.

12.5 Replacing bulbs, external



- ▶ Bulbs and light fittings can be extremely hot. Therefore, allow lights to cool down before changing bulbs.
- ▶ Store bulbs in a safe place inaccessible to children.
- ▶ Do not use any bulb that has been dropped or which shows scratches in its glass. The bulb might burst.



- ▷ A new bulb should not be touched with the fingers. Use a cloth when installing the new bulb.
- ▷ Use only bulbs of the same type and with the correct wattage (see table "Types of bulbs for exterior lighting").
- ▷ If an extendable motorcycle rack is fitted, only the rear lights of the motorcycle rack may function. The rear lights of the vehicle itself will not function.
- ▷ If LEDs in lights are defect, contact an authorised dealer or service centre.

Types of bulbs

Different types of bulbs are used in the vehicle. Below, we have described how to change the different types of bulbs.

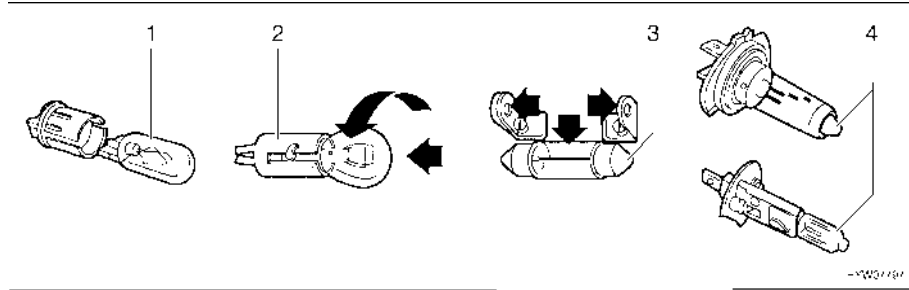

Fig. 121 Types of bulbs

Pos. in Fig. 121	Fixture type/bulb type	Changing
1	Plug-in fixture	To remove, pull out the bulb
		To mount, push the bulb into the socket with gentle pressure
2	Bayonet socket	To remove, press the bulb down and turn in an anticlockwise direction
		To insert, place the bulb in the socket and turn in a clockwise direction
3	Cylindrical bulbs	To remove and to insert, carefully bend the contacts of the lamp holder outwards
4	Halogen bulb	To remove, release retaining springs
		After inserting, hook the retaining springs again

12.5.1 Front lights



- ▷ The daytime running light burns when the ignition is switched on.
- ▷ When the daytime running light burns, the side marking lights do not burn.
- ▷ When the low beam is turned on, the daytime running light goes off.
- ▷ In extreme weather conditions or if the temperature fluctuates strongly, a light condensation film can form on the inside of the clear glass spotlight. The spotlight is designed so that this film evaporates when the spotlight is switched on or during driving. There is no risk of reduced lighting intensity or damage to the spotlight by condensation.

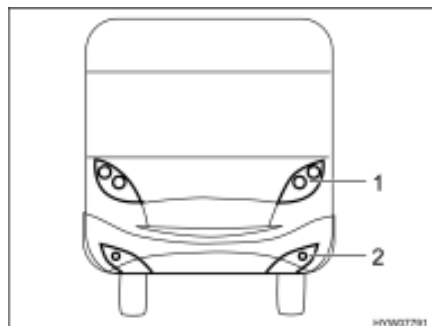

- 1 Front headlight
- 2 Curve light/fog light

Fig. 122 Front lights

Front headlight with direction indicator

The direction indicator is integrated into the front headlight.

The front headlight bulbs are changed from the engine compartment.



Fig. 123 Front headlight (front side)

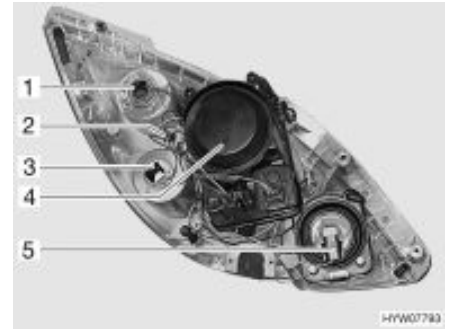

Fig. 124 Front headlight (rear side)

**Direction indicator
(Fig. 123,1 and Fig. 124,1)**

- Open the bonnet (see chapter 4).
- Turn the lamp holder with the lamp in an anticlockwise direction and remove.
- Turn the bulb in an anticlockwise direction and remove from the holder.
- Put in a new bulb.

**Parking light (Fig. 123,2
and Fig. 124,2)**

- Open the bonnet (see chapter 4).
- Turn the lamp holder with the lamp in an anticlockwise direction and remove.
- Turn the bulb in an anticlockwise direction and remove from the holder.
- Put in a new bulb.

**Daytime running light
(Fig. 123,3 and Fig. 124,3)**

- Open the bonnet (see chapter 4).
- Turn the lamp holder with the lamp in an anticlockwise direction and remove.
- Turn the bulb in an anticlockwise direction and remove from the holder.
- Put in a new bulb.

**Low beam (Fig. 123,4 and
Fig. 124,4)**

- Open the bonnet (see chapter 4).
- Remove the rubber cap from lamp housing.
- Turn the lamp holder with the lamp in an anticlockwise direction and remove.
- Turn the bulb in an anticlockwise direction and remove from the holder.
- Put in a new bulb.

**Main beam (Fig. 123,5 and
Fig. 124,5)**

- Open the bonnet (see chapter 4).
- Turn the lamp holder with the lamp in an anticlockwise direction and remove.
- Turn the bulb in an anticlockwise direction and remove from the holder.
- Put in a new bulb.

**Curve light/Fog light
(Fig. 122,2)**

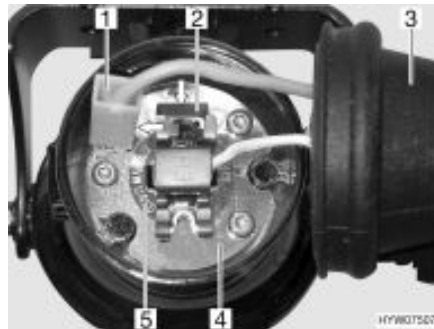

Fig. 125 Fog light

- Put your hand behind the fog light and remove rubber cap (Fig. 125,3) from lamp housing (Fig. 125,4).
- Remove negative cable (Fig. 125,1) from lamp housing.
- Press securing clips (Fig. 125,2) to remove and move them to the side.
- Remove bulb (Fig. 125,5) with cable from lamp housing.
- Put in a new bulb.

Adjusting the headlight

Depending on the model, the front headlights can be adjusted to left-hand traffic or right-hand traffic.



Fig. 126 Adjusting front headlight

- Open the bonnet (see chapter 4).
- Remove the rubber cap from lamp housing.
- Swivel the two adjusting levers (Fig. 126,1) to the other side.
- ▷ For resetting, swivel the adjusting levers back to their original position.



12.5.2 Rear lights

Only a service centre may replace the third brake light.

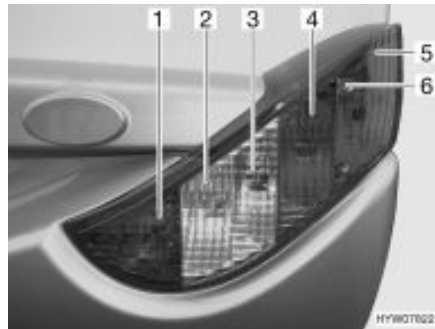

Fig. 127 Rear lights (front side)

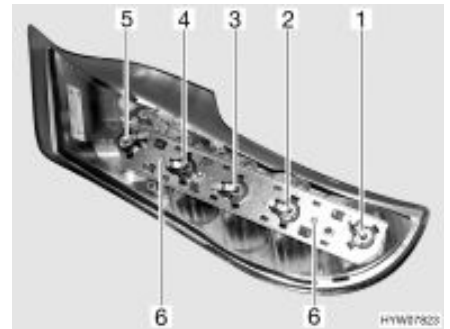

Fig. 128 Rear lights (rear side)

- Loosen three hexagon socket screws (Fig. 127,6)
- Remove housing.
- On the housing rear, remove the two Torx screws (Fig. 128,6) of the retainer.
- Change bulb.

Licence plate light

The licence plate light is the same for all models.



Fig. 129 Rear lights (licence plate light)

- Undo the two housing screws (Fig. 129,1).
- Remove housing.
- Change bulb.

12.5.3 Side lights

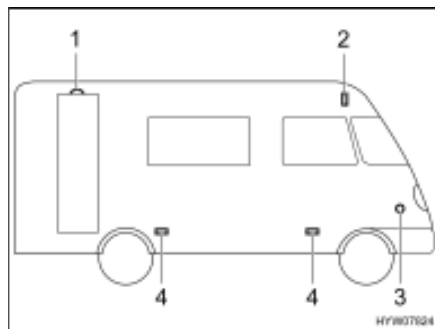

Fig. 130 Side lights

- 1 Awning light
- 2 Side marker light
- 3 Direction indicator
- 4 Marker light

- Awning light**
 - Loosen cover of housing.
 - Remove housing.
 - Change bulb.

- Side marker light**
 - Use a suitable tool (e.g. a screwdriver) to lever out the cover. Apply the tool to the notch in the housing.
 - Remove housing.
 - Change bulb.

- Direction indicator** The lamp is glued in. If the bulb is faulty, contact an authorised dealer or service centre.

- Marker light** The lights have LEDs. To change the LEDs, contact an authorised dealer or a service centre.

12.5.4 Types of bulbs for exterior lighting

	Item no.	Exterior lighting	Type of bulb
Front	1	Direction indicator	SV PY 12 V 21 W
	2	Parking light	P 12 V 5 W
	3	Daytime running light	PY 12 V 21 W
	4	Low beam	H11LL 12 V 55 W
	5	Main beam	H11LL 12 V 55 W
	-	Curve light/fog light	H7 12 V 55 W
Rear	1	Fog tail light	P 12 V 21 W
	2	Reverse light	P 12 V 21 W
	3	Direction indicator	P 12 V 21 W
	4	Brake light	P 12 V 21 W
	5	Rear light	P 12 V 5 W
	-	Licence plate light	C 12 V 5 W
	-	Third brake light	T5 12 V 2.3 W
Side	1	Awning light	12 V 5 W
	2	Side marker light	C 12 V 5 W
	3	Direction indicator	Contact a dealer or service centre
	4	Marker light	Contact a dealer or service centre

12.6 Replacing bulbs, internal



- ▶ Bulbs and light fittings can be extremely hot. Therefore, allow lights to cool down before changing bulbs.
- ▶ Shut off the power supply on the safety cut-out in the 240 V fuse box before changing bulbs.
- ▶ Store bulbs in a safe place inaccessible to children.



- ▶ Do not use any bulb that has been dropped or which shows scratches in its glass. The bulb might burst.
- ▶ Lights can get very hot. When the light is switched on, there must always be a safety distance of 30 cm between light and flammable objects. Fire hazard!



- ▷ A new bulb should not be touched with the fingers. Use a cloth when installing the new bulb.
- ▷ Only use bulbs of the same type and with the correct wattage.
- ▷ If LEDs in lights are defect, contact an authorised dealer or service centre.

12.6.1 Halogen spotlight



Fig. 131 Halogen spotlight

- Changing bulbs:*
- Pull the halogen bulb (Fig. 131,1) forward out of the socket.
 - Put in a new halogen bulb.

12.6.2 Recessed halogen light (flat)



Fig. 132 Recessed halogen light (flat)

The recessed halogen light (Fig. 132,2) is installed flush with the panel.

- Changing bulbs:*
- Use a suitable tool (e.g. a blunt knife) to lever out the internal cover ring with glass disk (Fig. 132,1) from the housing.
 - Remove halogen bulb.
 - Put in a new halogen bulb.
 - Reassemble the lamp in the reverse order.

12.6.3 Recessed halogen light



Fig. 133 Recessed halogen light

- Changing bulbs:*
- Use a suitable tool (e.g. a screwdriver) to lever out and remove the inner ring (Fig. 133,1) from the lamp.
 - Remove cover (Fig. 133,2).
 - Remove halogen bulb.
 - Put in a new halogen bulb.
 - Reassemble the lamp in the reverse order.

12.6.4 Garage light

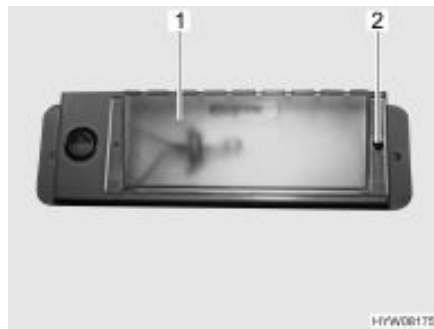

Fig. 134 Garage light

- Changing bulbs:*
- Undo the fastening screw (Fig. 134,2).
 - Remove the cover (Fig. 134,1).
 - Remove halogen bulb.
 - Put in a new halogen bulb.
 - Reassemble the lamp in the reverse order.

12.6.5 Changing the battery of the wardrobe light with LEDs

The wardrobe light contains 3 micro-batteries (AAA), which supply the LEDs with voltage.



Fig. 135 Wardrobe light

Changing the batteries:

- Push the cover (Fig. 135,1) of the wardrobe light in the direction of the arrow and remove.
- Remove the batteries.
- Put in new batteries correctly aligned (+/-).
- Replace and close the cover.

12.6.6 Types of bulbs for interior lighting

Interior lighting	Type of bulb
Halogen spotlight (halogen contact plug)	12 V 10 W
Recessed halogen light (halogen contact plug)	12 V 5 W
Recessed halogen light (halogen contact plug)	12 V 10 W
Recessed halogen light (cone spot halogen lamp)	12 V 10 W
Garage light (halogen contact plug)	12 V 10 W

12.7 Spare parts



- ▶ Every alteration of the original condition of the vehicle can alter road behaviour and jeopardize road safety.
- ▶ The special equipment and original spare parts recommended by **HYMER AG** have been specially developed and supplied for your vehicle. These products are available at the authorised dealers or service centres. The authorised dealers and service centres are informed about admissible technical details and carry out the required work correctly.
- ▶ The use of accessories, parts and fittings not supplied by **HYMER AG** may cause damage to the vehicle and jeopardize road safety. Even if an expert's report, a general type approval or a design certification exists, there is no guarantee for the proper quality of the product.
- ▶ No liability can be assumed for damage caused by products which have not been released by **HYMER AG**. This also applies to impermissible alterations to the vehicle.

For safety reasons, spare parts for pieces of equipment must correspond with manufacturer's instructions and be permitted by the manufacturer as a spare part. These spare parts may only be fitted by the manufacturer or an authorised specialist workshop. The authorised dealers and service centres are available for any spare parts requirement.

Here are some suggestions of important spare parts:

- Fuses
- V-belt
- Windscreen blades
- Bulbs
- Water pump (submerged pump)

When ordering spare parts, indicate the order number and the vehicle type to the authorised dealer or service centre.

The vehicle described in this instruction manual is built and equipped to factory standards. Special equipment is offered depending on its purpose or use. When fitting special equipment check if such equipment has to be entered in the vehicle documents. Observe the max. permissible gross weight. The authorised dealer or service centre will be happy to advise you.

12.8 Vehicle identification plate

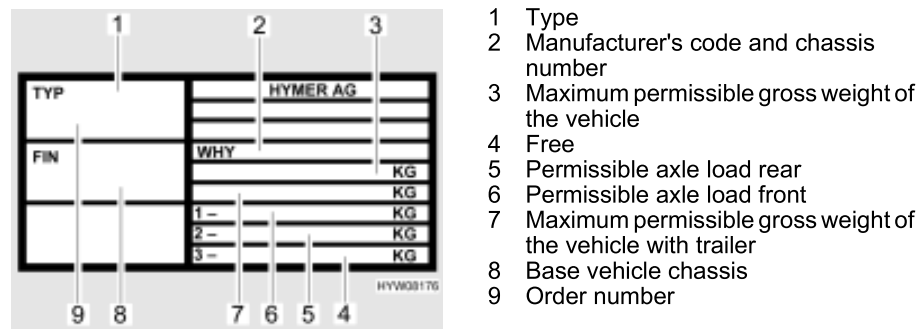

Fig. 136 Vehicle identification plate

The vehicle identification plate (Fig. 136) with the order number is mounted on the right hand side at the front just above the skirt.

Do not remove the vehicle identification plate. The vehicle identification plate:

- Identifies the vehicle
- Helps with the procurement of spare parts
- Together with the vehicle documents identifies the vehicle owner

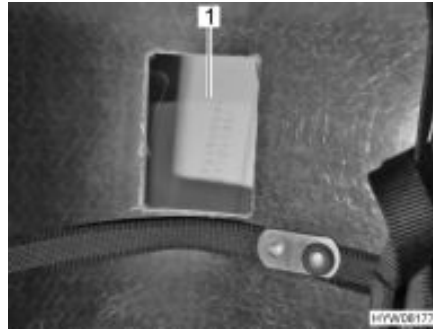

Fig. 137 Chassis number

The chassis number (Fig. 137,1) for the base vehicle is also accessible via recesses in the gas bottle compartment (Fig. 137).



- ▷ Always include the **order number** with all inquiries for the customer service office.

12.9 Warning and information stickers

There are warning and information stickers on and inside the vehicle. Warning and information stickers are for the sake of safety and must not be removed.



- ▷ Replacement stickers can be obtained from an authorised dealer or a service centre.

12.10 Dealers

Contact your authorised dealer or service centre whenever spare parts are needed for the vehicle.

You can find the addresses and telephone numbers of the authorised dealers and service centres:

- In the brochure "**HYMER** dealers", which is included separately with the vehicle
- In the Internet at <http://www.hymer.com>

12.11 Replacement key

To order replacement keys make a note of the following:

Locks for:	To order keys you need:	Obtainable at:	Telephone information:
Fiat base vehicle	Chassis number	Fiat authorised workshop	–
Alarm system	Second key	Thitronik	+49 431 6666828
Body	Order number, chassis number, second key or key number	Dealers	–

Chapter overview

This chapter contains instructions regarding the tyres of the vehicle.

The instructions address the following topics:

- tyre selection
- handling of tyres
- changing wheels
- spare wheel support

At the end of the chapter there is a table you can use to find the correct tyre pressure for your vehicle.

13.1 General



- ▶ Check tyre pressure before a journey or every 2 weeks. Wrong tyre pressure causes excessive wear and can lead to damage or even to tyre burst. You can lose control of the vehicle.



- ▷ Only check the tyre pressure on cold tyres.
- ▷ Tubeless tyres have been installed on the vehicle. Never install tubes in these tyres.
- ▷ Read the instruction manual for the base vehicle.



- ▷ Depending on the base vehicle and model the vehicles are only equipped with a tyre repair kit as standard.
- ▷ In the case of a puncture, pull over to the side of the road. Make vehicle safe with a hazard warning triangle. Switch on the warning lights.
- ▷ Tyres on vehicles with tandem axles may wear faster.
- ▷ Tyres must not be older than 6 years as the material will become brittle over time. The four-digit DOT number on the tyre flank indicates the date of manufacture. The first two digits designate the week, the last two digits the year of manufacture.

Example: **0510** Week 05, year of manufacture 2010.

Observe:

- Check the tyres regularly (every 2 weeks) for equal tread wear, tread depth and external damage.
- Replace tyres at the latest, when the minimum depth of tread stipulated by law is reached.
- Always use tyres of the same model, same brand and same style (summer and winter tyres).
- Only use tyres approved for the wheel rim type fitted. The permitted rim and tyre sizes are quoted in the vehicle documents and the authorised dealer or service centre will always be glad to give you advice.
- Run-in new tyres for approx. 100 km (60 miles) at low speed since only then do they reach full strength.

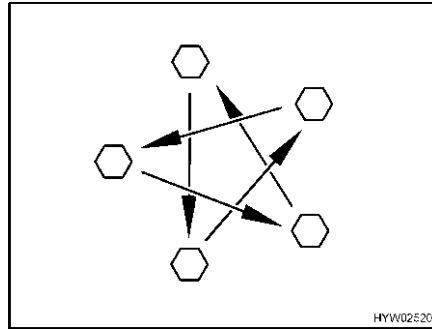

Fig. 138 Tighten the wheel nuts or wheel bolts cross-wise

- Check regularly that the wheel nuts or wheel bolts are firmly seated. Retighten the wheel nuts or wheel bolts of a changed wheel cross-wise (Fig. 138) after 50 km (30 miles). See section 13.5.2 for tightening torque.
- When using new or newly painted rims, re-tighten the wheel nuts or wheel bolts once again after approx. 1,000 to 5,000 km (600 miles to 3,000 miles).
- For lay-ups or long periods of inactivity, keep the tyres and tyre bearings free from pressure points:
Jack up the vehicle so that the wheels do not bear any load, or move the vehicle every 4 weeks in such a way that the position of the wheels is changed.

13.2 Tyre selection



- ▶ A wrong tyre can damage the tyres during the journey and even cause it to burst.



- ▷ If tyres that are not approved for the vehicle are used, then the type approval for the vehicle and subsequently the insurance coverage can lapse. The authorised dealer or service centre will be happy to advise you.

The tyre sizes approved for the vehicle are given in the vehicle documents or can be obtained from the authorised dealers or service centres. Each tyre must fit the vehicle on which it will be driven. This applies to the external dimensions (diameter, width), which are indicated with the standardised size designations. In addition, the tyres must meet the requirements of the vehicle with regard to weight and speed.

Weight refers to the maximum permissible axle load which can be distributed on two tyres. The maximum load-carrying capacity of a tyre is indicated by its load index (= LI, load index code).

The axle geometry of a vehicle, such as wheel camber and track, is also important for tyre selection. The maximum permissible speed for a tyre (with full load-carrying capacity) is indicated by the speed index (= SI). Together, load index and speed index form the operating code of a tyre. This is an official component of the complete, standardised dimensions description which appears on every tyre. The information on the tyres must correspond to the specifications which appear in the vehicle papers.

13.3 Tyre specifications

215/70 R 15C 109/107 Q

Description	Explanation
215	Tyre width in mm
70	Height-to-width proportion in percent
R	Tyre design (R = radial)
15	Rim diameter in inches
C	Commercial (transporter)
109	Load index code for single tyres
107	Load index code for twin tyres
Q	Speed index (Q = 160 km/h)

13.4 Handling of tyres

- Drive over kerbs at an obtuse angle. Otherwise the flanks of the tyres may get pinched. Driving over a kerb at a sharp angle can damage the tyre and result in it getting ruptured.
- Drive over high manhole covers at a slow speed. Otherwise the tyres may get pinched. Driving over a high manhole cover at high speed can damage the tyre and result in it getting ruptured.
- Check the shock absorbers regularly. Driving with poor shock absorbers significantly increases wear.
- If the tread wear is uneven, have the toe-in and the wheel camber checked. Driving with an incorrectly set toe-in or a one-sided wheel camber leads to a significant increase in wear.
- Avoid block brakings. Block braking gives the tyres "brake plates" of varying strength. This reduces driving comfort. It might even make the tyres unserviceable.
- Do not clean the tyres with a high-pressure cleaner. The tyres can suffer serious damage within just a few seconds and rupture as a result.
- Drive in such a way as to protect your tyres. Avoid braking sharply, revving up too strongly and long journeys on poor roads.

13.5 Changing wheels

13.5.1 General instructions



- ▶ The vehicle must be on level, firm ground, secure from slipping.
- ▶ Go into first gear. In the case of automatic transmission, change gear to "P" position.
- ▶ Before jacking up the vehicle firmly apply the handbrake.
- ▶ Prevent the vehicle from rolling away by blocking the opposite wheel with the wheel chocks.
- ▶ Under no circumstances jack the vehicle with the fitted supports.
- ▶ If a trailer is connected: Detach the trailer before lifting the vehicle.
- ▶ Position the vehicle jack underneath the axle, not under any circumstances on the bodywork.



- ▶ Never overload the vehicle jack. The maximum permissible load is specified on the vehicle jack's identification plate.
- ▶ Use the vehicle jack only for lifting the vehicle briefly while changing the tyre.
- ▶ Do not start the motor while the vehicle is jacked up.
- ▶ Whilst the vehicle is in a jacked up position, persons must not lie down under it.



- ▷ Do not damage the thread of the thread bolts when changing the wheel.
- ▷ Tighten the wheel nuts or wheel bolts cross-wise (Fig. 138).
- ▷ When changing wheels (e.g. alloy wheel rims or wheels with winter tyres), use the correct wheel bolts of the correct length and shape. The firm seating of the wheels and the function of the braking system depend on this.
- ▷ Wheel rims and tyres not permitted for use with the vehicle can jeopardize road safety.
- ▷ Do not replace wheels cross-wise.



- ▷ Protect the vehicle according to the national regulations, e.g. with a hazard warning triangle.
- ▷ Before changing the wheel, check the wheel rim and tyre size, the max. tyre load and the speed index on the tyres. Only use the wheel rim and tyre sizes stated in the vehicle documents.
- ▷ The on-board tool set is adapted to the mounted wheel nuts or wheel bolts. When alloy wheel rims are mounted, carry an appropriate tool for the spare wheel (steel wheel rim) in the vehicle.
- ▷ Further information can be found in the instruction manual of the base vehicle.

13.5.2 Tightening torque

Fiat base vehicle

Wheel rim	Tightening torque
Steel wheel rim 15"	160 Nm
Steel wheel rim 16"	180 Nm
Alloy wheel rim 15"	140 Nm
Alloy wheel rim 16"	160 Nm
Alloy wheel rim 17" (chassis "Light")	140 Nm
Alloy wheel rim 17" (chassis "Heavy")	160 Nm
Alloy wheel rim 20" (chassis "Light")	140 Nm
Alloy wheel rim 20" (chassis "Heavy")	160 Nm

13.5.3 Changing a wheel



- ▶ The footplate of the vehicle jack must be levelly positioned on the ground.



- ▷ You should have a useable spare wheel available at all times. For this reason the wheel you have replaced should be repaired immediately.
 - ▷ Take note of the general instructions in this chapter.
- Park the vehicle on as even and stable a surface as possible.
 - Go into first gear. In the case of automatic transmission, change gear to "P" position.
 - Apply the handbrake.
 - Place chocks or other appropriate objects beneath the vehicle to secure it.
 - Remove the spare wheel from the spare wheel support.
 - If the ground is soft, place a stable support such as a wooden board beneath the vehicle jack.
 - Position the vehicle jack at the designated mounting points.
 - Turn the wheel bolts several times to loosen them, but do not remove them.
 - Lift the vehicle until the wheel has been lifted 2 to 3 cm above the ground.
 - Remove the wheel bolts and take off the wheel.
 - Place the spare wheel on the wheel hub and adjust.
 - Screw in the wheel bolts and slightly tighten them cross-wise.
 - Crank down the vehicle jack and remove it.
 - Using the wheelbrace, tighten the wheel bolts evenly (see section 13.5.2 for tightening torque).

13.5.4 Changing a wheel at alloy wheel rims



- ▶ Alloy wheel rims and steel wheel rims require different wheel bolts. When alloy wheel rims are mounted, the spare wheel (steel wheel rim) is accompanied by suitable wheel bolts.

Wheels with alloy wheel rims are changed in the same way as wheels with steel rims (see section 13.5.3).

13.6 Spare wheel support

The spare wheel is in the rear storage space or in the rear garage.

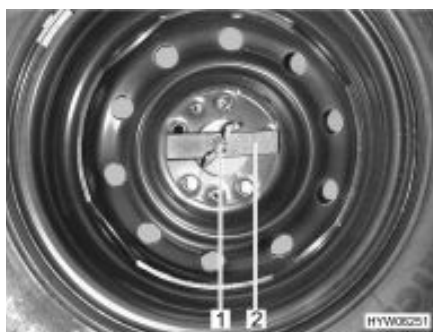

Fig. 139 Spare wheel in the rear storage space

Removing the spare wheel:

- Loosen the wing nut (Fig. 139,1) and unscrew it.
- Remove the pad (Fig. 139,2).
- Remove the spare wheel.

13.7 Tyre pressure



- ▶ Tyres overheat if the tyre pressure is too low. This can cause serious tyre damage.
- ▶ Check tyre pressure before a journey or every 2 weeks. Wrong tyre pressure causes excessive wear and can lead to damage or even to tyre burst. You can lose control of the vehicle.
- ▶ Use only valves that are approved for the specified tyre pressure.



- ▷ Only check the tyre pressure on cold tyres.

The payload and the durability of tyres is directly dependent on the tyre pressure. Air is a volatile medium. It is unavoidable that it will escape from tyres. As a rule of thumb it can be assumed that a filled tyre loses pressure at a rate of 0.1 bar every two months. To prevent the tyres becoming damaged or burst, check the tyre pressure regularly.



- ▷ The information on pressure levels is valid for cold tyres and loaded vehicles.
- ▷ Pressure in hot tyres must be 0.3 bar higher than in cold tyres. Recheck the pressure when the tyres are cold.
- ▷ The kg values refer to the actual axle load.
- ▷ Tyre pressures in bar.
- ▷ Over 4.75 bar requires a metal valve.
- ▷ The tyre pressure tolerance is +/- 0.05 bar.
- ▷ For the maximum permissible axle loads for your vehicle please refer to specific documentation.
- ▷ When a replacement is needed, **HYMER AG** recommends "Michelin-Camping" tyres.

The vehicles are constantly brought up to the newest technical standards. It is possible that new tyre sizes are not yet included in this table. If this is the case, any authorised dealer or service centre will be happy to provide the newest values.

Tyres	Tyre manufacturer	Tyre type/ Tyre name	2-axes		Maximum permissible gross weight (kg)	Maximum permitted rear axle load (kg)
			Front (bar)	Rear (bar)		
215/70 R 15C 109/107 R	Michelin	Camping	4.25	5.5	3500	2000
215/70 R 15C 109/107 R	Other makes	–	4.25	4.5	3500	2000
225/75 R 16C 116/114 R	Michelin	Camping	4.0	5.5	3500/ 4000	2400
225/75 R 16C 116/114 R	Other makes	–	4.0	4.75	3500/ 4000	2400

Tyres	Tyre manufacturer	Tyre type/ Tyre name	2-axes		Maximum permissible gross weight (kg)	Maximum permitted rear axle load (kg)
			Front (bar)	Rear (bar)		
255/55 R 17C	All	–	4.75	4.75	3500/ 4250	2400
255/55 R 17C	All	–	4	4	3500/ 4250	2000
265/50 R 20 112/chassis "Heavy"	All	–	2.9	2.9	4250	2240
275/45 R 20 110/chassis "Light"	All	–	2.9	2.9	3850	2000

Chapter overview

This chapter contains instructions about possible faults in your vehicle. The faults are listed with their possible causes and corresponding remedies. The instructions address the following topics:

- braking system
- electrical system
- gas system
- gas cooker
- gas oven
- heater
- boiler
- refrigerator
- water supply
- body

The specified faults can be remedied with relative ease and without a great deal of specialised knowledge. In the event that the remedies detailed in this instruction manual should not be successful, an authorised specialist workshop must find and eliminate the cause of the fault.

14.1 Braking system



- ▶ Have defects on the braking system immediately remedied by an authorised specialist workshop.

14.2 Electrical system



- ▶ When the living area battery is changed, only use batteries of the same type.



- ▶ See chapter 8 for changing the fuses.

Fault	Cause	Remedy
Road light system does no longer work correctly	Bulb is defective	Unscrew cover of the relevant light, replace bulb. Note volts and watts specifications
	Fuse on the transformer/rectifier is defective	Replace fuse on the transformer/rectifier
Interior lighting does not work	Bulb is defective	Remove cover, replace bulb. Note volts and watts specifications
The electrically operated entrance step cannot be moved in or out	Fuse on the transformer/rectifier is defective	Replace fuse on the transformer/rectifier
No 240 V power supply despite connection	240 V automatic circuit breaker has triggered	Switch on the 240 V automatic circuit breaker

Fault	Cause	Remedy
Starter or living area battery is not charged when operated in 240 V mode	Fuse on the transformer/rectifier is defective	Replace fuse on the transformer/rectifier
	Charger module in the transformer/rectifier is defective	Contact customer service
Living area battery is not charged during vehicle operation	Fuse on terminal D+ of the alternator is defective	Replace fuse
	Disconnecter relay in the transformer/rectifier is defective	Contact customer service
12 V indicator lamp does not light up	12 V power supply switched off	Switch 12 V power supply on
	Battery cut-off switch or main switch on the transformer/rectifier is switched off	Switch battery cut-off switch or main switch on
	Starter or living area battery is not charged	Charge the starter or living area battery
	Disconnecter relay in the transformer/rectifier is defective	Contact customer service
12 V power supply does not work	12 V power supply switched off	Switch 12 V power supply on
	Battery cut-off switch or main switch on the transformer/rectifier is switched off	Switch battery cut-off switch or main switch on
	Living area battery is discharged	Charging the living area battery
	Disconnecter relay in the transformer/rectifier is defective	Contact customer service
12 V power supply does not work in 240 V operation	12 V power supply switched off	Switch 12 V power supply on
	Battery cut-off switch or main switch on the transformer/rectifier is switched off	Switch battery cut-off switch or main switch on
	240 V automatic circuit breaker has triggered	Contact customer service
	Charger module in the transformer/rectifier is defective	Contact customer service

Fault	Cause	Remedy
Starter battery is discharged in 12 V operation	Disconnecter relay in the transformer/rectifier is defective	Contact customer service
	Battery cut-off switch or main switch on the transformer/rectifier is switched off	Switch battery cut-off switch or main switch on
No voltage is supplied by the living area battery	Living area battery is discharged	<p>Charge living area battery immediately</p> <p> ▷ Total discharge damages the battery.</p> <p>If the vehicle is to be laid up for a long period, fully charge the living area battery beforehand</p> <p>Discharging is caused by inactive appliances (see chapter 8)</p>

14.3 Gas system



- ▶ In case of a defect of the gas system (gas odour, high gas consumption) there is danger of explosion! Close regulator tap on the gas bottle immediately. Open doors and windows and ventilate well.
- ▶ If the gas system is defective: Do not smoke; do not ignite any open flames, and do not operate electric switches (light switches etc.).
- ▶ Have the defective gas system repaired by an authorised specialist workshop.

Fault	Cause	Remedy
No gas	Gas bottle is empty	Change gas bottle
	Gas isolator tap closed	Open the gas isolator tap
	Regulator tap on the gas bottle is closed	Open regulator tap on the gas bottle
	External temperature is too low (-42 °C for propane gas, 0 °C for butane gas)	Wait for higher external temperatures
	Built-in appliance is defective	Contact customer service

14.4 Gas cooker/gas oven

Fault	Cause	Remedy
Ignition fuse does not operate (flame does not burn after the control knobs are released)	Heat-up time is too short	Keep control knob pressed for approx. 15 to 20 seconds after ignition
	Ignition fuse is defective	Contact customer service
Flame extinguishes when being reduced to its minimum setting	Thermocouple sensor is incorrectly set	Correctly reset thermocouple sensor (do not bend). The sensor tip should protrude by 5 mm beyond the burner. The sensor neck should not be more than 3 mm away from the burner ring; if necessary, contact customer service

14.5 Heater/boiler

In the event of a defect contact the nearest customer service workshop of the relevant appliance manufacturer. The list of addresses is enclosed with the accompanying appliance documentation. Only authorised qualified personnel may repair the appliance.

14.5.1 Truma heater/boiler

Fault	Cause	Remedy
Heater does not ignite	Temperature sensor on operating unit or remote sensor defective	Pull out plug on operating unit. The heater then works without thermostat. Contact the customer service as soon as possible
Red indicator lamp "Fault" illuminates	Air in the gas pipe system	Switch off and on again. After two futile ignition attempts, wait for 10 minutes before trying again
	Lack of gas	Open regulator tap and gas isolator tap
		Connect a full gas bottle
	Defect of a safety element	Contact customer service
Red indicator lamp "Fault" is flashing	Operating voltage too low	Charge or replace the living area battery (or have it charged or replaced)

Fault	Cause	Remedy
Green indicator lamp behind knob is not lit	Fuse on the transformer/rectifier is defective	Replace fuse on the transformer/rectifier
	Fuse in the electronic control unit has been triggered	Contact customer service
	Living area battery defective	Charge or replace the living area battery (or have it charged or replaced)
Yellow indicator lamp on the energy selector switch does not illuminate	No supply voltage	Check 240 V connection and fuses
	Overheating switch was triggered	Press overheating switch
Boiler empties, safety/drainage valve has opened	Internal temperature below 8 °C	Heat inside
Red and green indicator lamps are not lit	Fuse is defective	Replace fuse on the transformer/rectifier
Fan wheel runs noisily or not steadily	Fan wheel is soiled	Contact Truma service department

14.5.2 Alde heater/boiler

Fault	Cause	Remedy
Heater does not ignite with gas operation	Lack of gas	Open regulator tap and gas isolator tap
		Connect a full gas bottle
Heater does not ignite at 240 V electrical operation	No 240 V power supply	Switch on the 240 V automatic circuit breaker
		Connect 240 V power supply
Heater running, but no heat at the convectors	Circulating pump does not work	Switch on room thermostat
		Contact customer service
Heater and circulating pump running, but no heat at the convectors	Air in the heating system	Bleed hot-water heater

14.6 Refrigerator

In the event of a defect contact the nearest customer service workshop of the relevant appliance manufacturer. The list of addresses is enclosed with the accompanying appliance documentation. Only authorised qualified personnel may repair the appliance.

14.6.1 Dometic refrigerator 7 series with AES

Fault	Cause	Remedy
Indicator lamps "230 V", "12 V" or "AUTO" are not lit green	Refrigerator is turned off	Switch on the refrigerator with energy selector switch
	No electrical operating voltage	Connect 240 V power supply
		Let the vehicle engine run
		Switch on or replace the fuse
	Contact a specialist workshop	
Refrigerator does not switch to 12 V mode during the journey	Operating voltage of alternator is not present/ too low	Contact a specialist workshop
Refrigerator does not switch on in gas operation, "GAS" indicator lamp is not lit yellow	Lack of gas	Open regulator tap and gas isolator tap
		Connect a full gas bottle
	Cobwebs or burnt residue in the burning chamber	Remove the ventilation grill on the outside of the vehicle and clean the burning chamber
"GAS" indicator lamp flashes yellow, no gas	Air in the gas pipe	Switch off the refrigerator with energy selector switch
		Open regulator tap on the gas bottle and the gas isolator tap of the refrigerator
		Switch on the refrigerator with energy selector switch. After 10 seconds, the AES will attempt another ignition
		If the "GAS" indicator lamp flashes yellow again after approx. 30 seconds, the failure has not been remedied yet
		Repeat this process two to three times for ventilation. If the refrigerator cannot be operated, contact customer services

14.6.2 Dometic 8 series with MES



▷ In the case of a fault the LED display fault will always light up "⚠".

Fault	Cause	Remedy
LED "⚡" flashes	No 240 V power supply	Connect 240 V power supply
	240 V automatic circuit breaker has triggered	Switch on the 240 V automatic circuit breaker
	240 V operating voltage too low	Have the 240 V power supply checked by an authorised specialist workshop
LED "⊕" flashes	Fuse on the transformer/rectifier is defective	Replace fuse on the transformer/rectifier
	Disconnecter relay in the transformer/rectifier is defective	Contact customer service
	12 V operating voltage too low	Have the 12 V power supply checked by an authorised specialist workshop
LED "🔥" flashes	Lack of gas	Open regulator tap and gas isolator tap
		Connect a full gas bottle
	Cobwebs or burnt residue in the burning chamber	Remove the ventilation grill on the outside of the vehicle and clean the burning chamber
LEDs for display of the temperature range flash	Temperature sensor defective	Contact customer service
LED "⚡" and LEDs for display of the temperature range flash	240 V heater element defective	Contact customer service
LED "⊕" and LEDs for display of the temperature range flash	12 V heater element defective	Contact customer service

14.6.3 Dometic 8 series with AES



▷ In the case of a fault the LED display fault will always light up "⚠".

Fault	Cause	Remedy
Text "230 V" flashes	No 240 V power supply	Connect 240 V power supply
	240 V automatic circuit breaker has triggered	Switch on the 240 V automatic circuit breaker
	240 V operating voltage too low	Have the 240 V power supply checked by an authorised specialist workshop
Text "12 V" flashes	Fuse on the transformer/rectifier is defective	Replace fuse on the transformer/rectifier
	Disconnecter relay in the transformer/rectifier is defective	Contact customer service
	12 V operating voltage too low	Have the 12 V power supply checked by an authorised specialist workshop
Text "GAS" flashes	Lack of gas	Open regulator tap and gas isolator tap
		Connect a full gas bottle
	Cobwebs or burnt residue in the burning chamber	Remove the ventilation grill on the outside of the vehicle and clean the burning chamber
LEDs for display of the temperature range flash	Temperature sensor defective	Contact customer service
Text "HE1" flashes	240 V heater element defective	Contact customer service
Text "HE2" flashes	12 V heater element defective	Contact customer service

14.7 Water supply

Fault	Cause	Remedy
Leakage water inside the vehicle	A leak has occurred	Identify leak, re-connect water pipes
No water	Water tank is empty	Replenish drinking water
	Drain cock not closed	Close drain cock
	12 V power supply switched off	Switch 12 V power supply on
	Fuse of the water pump is defective	Replace fuse on the transformer/rectifier
	Water pump defective	Exchange water pump (have it exchanged)
	Water pipe snapped off	Straighten water pipe or replace
	Transformer/rectifier defective	Contact customer service
Toilet has no flush water	Water tank is empty	Replenish drinking water
	Fuse of the sewage tank is defective	Replace fuse
Display for water and waste water indicates a wrong value	Measuring probe in the waste water or water tank is soiled	Clean water/waste water tank
	Measuring probe is defective	Replace measuring probe
Waste water tank cannot be emptied	Drain cock is clogged	Open the cleaning cap on the waste water tank and drain the waste water. Rinse the waste water tank well
Drain on the one-hand lever mixer is clogged	Perlator calcified	Unclip the perlator, de-calcify in vinegar water (only for products made from metal)
Water jets on the shower nozzle clogged	Water jets calcified	De-calcify shower nozzle in vinegar water (only for products made from metal) or rub off soft nozzle burling
Water drains from the shower tray slowly or does not drain at all	The vehicle is not in a horizontal position	Position the vehicle horizontally
Milkiness of the water	Tank filled with dirty water	Clean water tank mechanically and chemically; then disinfect and rinse copiously with drinking water
	Residues in the water tank or water system	Clean water system mechanically and chemically; then disinfect and rinse copiously with drinking water

Fault	Cause	Remedy
Any change in the taste or odour of the water	Tank filled with dirty water	Clean water system mechanically and chemically; then disinfect and rinse copiously with drinking water
	Fuel filled into the water tank by mistake	Clean water system mechanically and chemically; then disinfect and rinse copiously with drinking water. If not successful: Contact a specialist workshop
	Microbiological deposits in the water system	Clean water system mechanically and chemically; then disinfect and rinse copiously with drinking water
Deposits in the water tank and/or water-carrying components	Water excessively long in the water tank and in water-carrying components	Clean water system mechanically and chemically; then disinfect and rinse copiously with drinking water

14.8 Body

Fault	Cause	Remedy
Flap hinges/door hinges are difficult to operate	Flap/door hinges are not sufficiently lubricated	Lubricate flap hinges/door hinges with acid-free and resin-free grease
Hinges/joints in the bathroom unit/toilet compartment are difficult to operate/make a grating noise	Hinges/joints are not sufficiently lubricated	Lubricate hinges/joints with solvent-free and acid-free grease  ▷ Spray cans often contain solvents
Storage compartment hinges are difficult to operate/make a grating noise	Storage compartment hinges are not sufficiently lubricated	Lubricate storage compartment hinges with acid-free and resin-free grease
Front bonnet swivel system is difficult to operate	Front bonnet swivel system is not (sufficiently) lubricated	Lubricate front bonnet swivel system with acid-free and resin-free grease
Wind-up skylight is difficult to operate	Threaded spindle not lubricated	Lubricate threaded spindle
	Threaded spindle defective	Have threaded spindle replaced



▷ The authorised dealers and service centres are available for any spare parts requirement.

15.1 Weight details for special equipment



- ▶ The use of accessories, parts and fittings not supplied by **HYMER AG** may cause damage to the vehicle and jeopardize road safety. Even if an expert's report, a general type approval or a design certification exists, there is no guarantee for the proper quality of the product.
- ▶ Every alteration of the original condition of the vehicle can alter road behaviour and jeopardize road safety.
- ▶ No liability can be assumed for damage caused by products which have not been released by **HYMER AG**. This also applies to impermissible alterations to the vehicle.

Weight details for **HYMER** special equipment are listed in the table below. If these objects are either carried in or on the vehicle and are not part of the standard equipment, they must be taken into consideration when calculating the payload.

All weight details are approximate.

Observe the max. permissible gross weight.

Item designation	Surplus weight (kg)
Waste water tank, insulated	14
Alloy wheel rims	-15
Caravan coupling	26
Heated and electrically adjustable external mirror	4
Outer storage space flap	1
Car radio and CD	2
Oven	10
Front passenger's swivel seat	4
Floor carpet	8
Skylight with integrated shade	2
Skylight (Fantastic-Vent)	3
Roof rail with ladder	17
DuoControl	2
Driver's door	24
Bike rack for 2 bicycles	6
Bike rack for 3 bicycles	8
Bike rack for 4 bicycles	11
Roman shades, driver's cabin	7.5
Fire extinguisher	3
Flat screen	5.5
Holder for flat screen	2.5
Driver's cabin floor mat, one-piece	3
Garage under rear bed	10-20
Remote gas switch	1
Gas grill	6

Item designation	Surplus weight (kg)
Gas socket with stopcock	1
Insulation mat for driver's cabin window	3
Driver's cabin insulating glass	5
Driver's cabin air conditioning unit	30
Air conditioning unit	35
Steady legs, 2 pcs.	9
Curve light	2
150-litre refrigerator	14
Refrigerator with oven	24
Awning 300 cm	25
Awning 350 cm	32
Awning 400 cm	40
Awning 450 cm	45
Awning 500 cm	50
Removable motorcycle rack	40
Extendable motorcycle rack	32
Navigation system	2.5
Fog light	1
Mains supply (garage rear wall)	2
Panorama skylight	12
Radio preparation including antenna and loudspeakers	3
Reversing video system	2
Reverse warner	2
Satellite unit (Omnisat)	12
Satellite unit (Oyster 85)	14.5
Safety lock	0.5
Solar installation, 2 x 50 W, regulated	15
Carpet	8
Toilet ventilation	0.5
Ultrasonic alarm system inclusive door contact	1
Underfloor sliding drawer, additional	12
Hot-water heater	30
Additional heater, driver's cabin	5
Additional cushion	5
Second living area battery	20

16.1 Technical data



- ▷ Only the details provided in the actual vehicle documentation shall be binding with regard to the technical data.
- ▷ The measurements as well as the net weight of the vehicle may change when mounting accessories or special equipment. Differences due to manufacturing tolerances (+/- 5 %) are possible and admissible.

Further information can be found in the manual of the base vehicle. The technical data are not a component of the instruction manual.

The technical data can be obtained from the manufacturer's documentation. Alternatively, the authorised dealer or service centre will also be happy to advise you.

12 V appliance, retrofitting 93

12 V fuses 98

 For Thetford toilet 101

 On the living area battery 99

 On the relay box AD01 100

 On the starter battery 99

 On the transformer/rectifier (EBL 99) 100

12 V indicator lamp 94

12 V main switch 94

12 V power supply 86

 Switching off 94

 Switching on 94

 Troubleshooting 176

240 V connection 54, 97

 Power cable 97

 Troubleshooting 175

240 V fuse 102

240 V fuse box 102

240 V indicator lamp 96

240 V power supply 97

A

AC converter 86

Access ladder, pull-down bed 75

Accessories, fitting 22

Adapter cable 98

Additional equipment 29

Add-on parts see special equipment 22

Adjusting the headlight 158

Air outlet nozzles, adjustment 106

Alloy wheel rims 171

Antenna alignment 73

Appliances 105

 Manuals 22

Armrest, adjustment 46

Automatic power selection (AES) 122, 126

Auxiliary fan

 Hot-water heater 112

 Position 112

 Switching off 113

 Switching on 113

Auxiliary heat exchanger

 Switching off 114

 Switching on 114

Awning 55

Awning light 160

B

Basic equipment 28

Battery alarm 96

Battery cut-off switch 92

Battery monitor 92

Battery see starter battery or living area battery 87, 88

Battery selector switch 92

Battery voltage, displaying 94

Battery, wardrobe light, changing 163

Beds 74

Before the journey 27

Bike rack

 Load 35

 Travelling with a loaded bike rack 35

Blind, cleaning 144

Blind, windscreen 48

 Closing 67

 Emergency operation 67

 Opening 67

 Securing 49

Boiler (Alde)

 Emptying 118

 Switching off 118

 Switching on 118

 Water, filling with 118

Boiler (Truma) 115

 Emptying 117

 Operating modes 115

 Safety/drainage valve 115

 Summer operation 116

 Switching off 116

 Switching on 116

 Water, filling with 117

 Winter operation 116

Bonnet 50

 Closing 50

 Opening 50

Brakes 44

 Check 44, 175

Braking system, troubleshooting 175

Bulbs, changing 155, 160

 Exterior lighting 155

 Front lights 156

 Garage light 162

 Halogen spotlight 161

 Interior lighting 160

 Licence plate light 159

 Rear lights 159

- Recessed halogen light 161, 162
 Side lights 159
 Types of bulbs, interior 163
 Types of external bulbs 160
 Butane gas 25, 80
- C**
- Cable reel 97
 Camping gas bottles, use 26, 80
 Capacity of the battery 86
 Caravan coupling 36
 Care 141
 Blind 144
 Carpet 144
 Curtains 144
 Entrance step 143
 External care 141
 Furniture surfaces 144
 Gas cooker 144
 GRP add-on parts 142
 High-pressure cleaner, washing with 141
 Hot-water heater 153
 In the winter 147
 Insect screen 144
 Interior care 143
 Lamps 144
 Leather covers 144
 Net curtains 144
 PVC-floor covering 144
 Roman shade 144
 Seat belt 144
 Sink 144
 Synthetic parts, interior 144
 Temporary lay-up 148
 Underbody 143
 Upholstery 144
 Washing 142
 Waste water tank 143
 Water system 146
 Windows 142
 Winter lay-up 149
 Carpet, cleaning 144
 Changing wheels 169
 Tightening torque 170
 With alloy wheel rims 171
 Checklist 39, 148
 Before the journey 39
 Initial start-up after temporary lay-up 150
 Road safety 39
 Start-up 15
 Temporary lay-up 148
 Winter lay-up 149
 Child restraint systems 45
 Suitable seats 45
 Children's beds 74, 75
 Circulation fan 106
 Cleaning
 Water pipes 146
 Water tank 146
 Cleaning see care 141
 Closed circuit current 85
 Condensation 61
 On the double acrylic glass pane 62
 On the screwed connections in the
 floor 61
 Condensation water see condensation 62
 Connecting cable see power cable 97
 Conventional load 29
 Conversion door 57
 Insect screen 59
 Conversion door, inside
 Locking 58
 Opening 58
 Conversion door, outside
 Locking 57
 Opening 57
 Cooker 119
 Curtains, cleaning 144
 Curve light, switch on 43
 Customer service 153
- D**
- Danger of suffocation 22, 61
 Daytime running light 157
 Dealers 165
 Dimensions see technical data 187
 Direction indicator 157, 160
 Displays
 Battery voltage 94
 Waste water tank level 95
 Water tank level 95
 Disposal
 Household waste 18
 Sewage 18
 Waste water 18
 Door lock 57, 58

Doors		Exterior lighting	
Conversion door	57	Bulbs, changing	155
Driver's door	57	Checking	39
Lock	57, 58	Troubleshooting	175
Troubleshooting	184	External care	141
Drain cock, waste water tank	134	External connection see 240 V connection	54
Drain cocks, position	140	External flaps	59
Drinking water filler neck	132	Flap lock	59, 60, 61
Closing	132	External gas connection	82
Opening	132	External mirrors, electrically adjustable	
Driver's door	57, 58	Adjusting	48
Driver's door, inside		Mirror heater, switching on	48
Locking	59		
Opening	59	F	
Driver's door, outside		Fault current protection switch	97
Locking	58	Check	102
Opening	58	Filling the tank	51
Driver's seat	45	Fire	
Armrest, adjustment	46	Behaviour in the event of	21
Backrest, adjustment	46	Extinguishing	21
Moving in lengthways direction	46	Fire prevention	21
Seat inclination, adjustment	46	Fire risks, avoidance	21
Turning it to driving position	46	Fixed table with rigid table leg	
Driving speed	42	Table-top, moving in a crossways	
Driving the motorhome	41	direction	71
DuoControl switching facility	83	Table-top, moving in a lengthways	
During the journey	41	direction	71
		Table-top, rotating	71
		Flap lock	
E		Closing	60
Electrical system	85	Elliptical-shaped	60
240 V connection, troubleshooting	175	Opening	60
Entrance step, troubleshooting	175	Underfloor sliding drawer	61
Explanation of terms	85	Flashing indicator see direction indicator	160
Lighting, troubleshooting	175	Flat screen	37
Safety instructions	26	Positioning	72
Troubleshooting	175	Securing	37
Electrical window winder		Storing	38
Closing	48	Fog light	158
Opening	48	Switching on	43
Electrically adjustable external mirrors	48	Forced ventilation	22, 61
Entrance step	36, 53	Freezer compartment door locking	
Care	143	mechanism	
Extending	36	Closing	129
Retracting	36	Locking in the ventilation position	129
Troubleshooting	175	Opening	129
Warning tone	36	Front passenger's seat	45
Environmental tips	18	Armrest, adjustment	46
		Backrest, adjustment	46

Moving in lengthways direction	46
Seat inclination, adjustment	46
Turning it to driving position	46
Fuel filler neck	51
Closing	51
Opening	51
Furniture flaps, troubleshooting	184
Furniture surfaces, cleaning	144
Fuses	
12 V fuses	98
240 V fuse	97, 102
For the Thetford toilet	101
On the living area battery	99
On the relay box AD01	100
On the starter battery	99
On the transformer/rectifier (EBL 99)	100
Fuses see 12 V fuses and 240 V fuse	98

G

Garage light	162
Gas bottle compartment	25, 80
Gas bottles	
Changing	81
Safety instructions	25, 80
Gas connection, external	82
Gas cooker	
Cleaning	144
Switching off	120
Switching on	120
Troubleshooting	178
Gas isolator taps	82
Symbols	82, 105
Gas odour	24, 79, 177
Gas oven	121
Switching off	121
Switching on	121
Gas system	79
Defect	24, 79, 177
General instructions	24
Safety instructions	79
Switching automatics	83
Troubleshooting	177
Gas tube, check	25, 80
General instructions	18
GRP add-on parts, care	142
Guarantee	3

H

Halogen spotlight	161
Handbrake	53
Applying	22
Handling of tyres	169
Headlight, adjusting	158
Headrests	47
Heat exchanger	
Switching off	114
Switching on	114
Heat exchanger (Alde)	
Switching off	111
Switching on	111
Heat exchanger, heater, replacement	105
Heater	105
Air outlet nozzles, adjustment	106
Circulation fan	106
Heat exchanger, replacement	105
Hot air distribution	106
Initial start-up	106
Troubleshooting	178
Heater, external mirrors	48
High rate of gas consumption	24, 79, 177
High-pressure cleaner, washing with	141
Hinged skylight	68
Closing	68
Insect screen	69
Locking in ventilation position	69
Opening	68, 69
Roman shade	69
Hinged window	
Closing	63
Continuous ventilation	64
Insect screen	65
Opening	63
Roman shade	65
Hot air distribution	106
Hot-air heater	
Circulation fan	106
Operating modes	106, 107
Switching off	107
Switching on	107
Hot-water heater	
240 V electrical operation, selecting	110
Adjustment menu	109
Auxiliary circulating pump	111
Auxiliary fan	112
Care	153
Fluid level, checking	154

Gas and 240 V electrical operation, selecting	110	Interior care	143
Gas operation, selecting	110	Interior lighting	
Heat distribution	110	Bulbs, changing	160
Heat exchanger	111	Troubleshooting	175
Heater, switching off	110	Types of bulbs	163
Heater, switching on	110	Internet address	1
Heating fluid, topping up	154		
Heating system, bleeding	155	L	
Maintenance work	153	Ladder, rear	32
Operating modes	110	Lamps	160
Operating unit	109	Cleaning	144
Safety instructions	108	Lay-up	
Start screen	109	Temporary	148
Tool menus	110	Temporary (toilet)	140
		Winter lay-up	149
I		Leakage water inside the vehicle	183
Impermeability	4	Leather covers, cleaning	144
Independent vehicle heater		Light metal wheel rims see alloy wheel rims	171
Maintenance	155	Lighting	
Programming	113	Bulbs, changing	155
Switching off	113	Front	156
Switching on	113	Lamps, cleaning	144
Indicator lamp, 12 V	94	Rear	159
Indicator lamp, 240 V power supply	96	Side	159
Indicator lamp, toilet	138	Troubleshooting	175
Information stickers	165	Types of external bulbs	160
Inner door, troubleshooting	184	Types of internal bulbs	163
Insect screen, cleaning	144	Living area battery	88
Insect screen, conversion door		Battery alarm	96
Closing	59	Charging	90
Opening	59	Discharging	89
Insect screen, hinged skylight		Fuses	99
Closing	69	Instructions	88
Opening	69	Troubleshooting	176, 177
Insect screen, sunroof		Voltage, displaying	94
Closing	66	Load	31
Opening	66	Bike rack	35
Insect screen, windows		Rear garage	34
Closing	65	Rear storage space	34
Opening	66	Roof rack	32
Insect screen, wind-up skylight		Underfloor sliding drawer	35
Closing	70	Load rack for roof loads	33
Opening	70	Load see also payload	31
Inspection	5	Lock	
Inspection record		Conversion door	57
Body inspection	7, 8, 9, 10	Driver's door	58
Water ingress test	7, 8, 9	External flap	59, 60, 61
Inspection work	153	Low beam	157
Inspections	153		

M

Main beam	157
Maintenance	153
Maintenance work	153
Hot-water heater	153
Independent vehicle heater	155
Marker light	160
Mass in ready-to-drive condition	28, 30
Maximum permissible gross weight	28, 30
Mechanical steady legs	
Extending	54
Length, adjustment	54
Retracting	54

N

Net curtains, cleaning	144
No gas	177
Nose weight	36

O

Off-load voltage	85
Oil level, checking	51
Operating modes	
Boiler (Truma)	115
Hot-air heater	106, 107
Hot-water heater	110
Refrigerator	122, 124, 126
Switching automatics, gas system	84
Order number	165
Oven see gas cooker or gas oven	119, 121
Overloading	31

P

Panel (LT 95)	93
Panel see also displays	93
Parking distance control	42
Switching off	43
Parking light	157
Payload	27
Calculation	30
Composition	29
Example calculation	28, 30
Payload see also load	27
Permissible gross weight see maximum permissible gross weight	27
Permitted mass	28
Personal equipment	29
Power cable for the 240 V connection	97

Propane gas	25, 80
Pull-down bed	
Access ladder	75
Closing	74
Opening	74
Retaining belts, tightening	75
Pull-down bed, electrically operated	75
Closing	76
Emergency operation	77
Making ready for operation	76
Opening	76
Overload protection	76
PVC-floor covering, cleaning	144

R

Rear axle load	36
Rear garage	34
Rear ladder	32
Folding downwards	33
Folding upwards	34
Rear storage space	34
Recessed halogen light	161, 162
Refrigerator	54, 121
12 V operation, switching on/off	126
240 V operation, switching on/off	126
Change-over between energy sources	123, 127
Door lock	128, 129
Frame heater	124
Gas operation, switching off	125
Gas operation, switching on	125
Operating modes	122, 124, 126
Operation	124, 128
Refrigerating temperature control	123, 127
Switching off	124, 128
Switching on	124, 128
Troubleshooting	179, 180
Ventilation grill, removal	122
Refrigerator door locking mechanism	
Closing	129
Locking in the ventilation position	129, 130
Opening	129
Refrigerator ventilation grill, removal	122
Replacement key	165
Risk of frost damage	26, 131, 136
Road safety	39
Checklist	39
Notes for	22
Roman shade, cleaning	144

Roman shade, driver's window	49	Serial number	164
Closing	67	Service centres, directory	1
Opening	67	Set of keys	27
Securing	49	Sewage tank	
Roman shade, front passenger's window	49	Emptying	139
Closing	67	Removal	139
Opening	67	Retaining clip	139
Securing	49	Shower	136
Roman shade, hinged skylight		Side marker light	160
Closing	69	Sink, cleaning	144
Opening	69	Skylights	67, 68
Roman shade, sunroof		Sliding window	
Closing	66	Closing	63
Opening	66	Opening	63
Roman shade, windows		Snow chains	38
Closing	65	Spare parts	163
Opening	65	Spare wheel	171
Roman shade, wind-up skylight		Spare wheel support	171
Closing	70	Special equipment	185
Opening	70	Description	17
Roof load	32	Marking	17
Roof rack, load	32	Safety instructions	22
Roof rail	32	Weight details	185
		Starter battery	
S		Battery alarm	96
Safety instructions	21	Charging	87
Changing wheels	169	Discharging	87
Cooker	119	Fuses	99
Electrical system	26	Position	87
Fire prevention	21	Troubleshooting	176
Gas bottles	80	Voltage, displaying	94
Gas system	79	Start-up	27
Hot-water heater	108	After temporary lay-up	150
Road safety	22	After winter lay-up	150
Towing	24	Checklist	15
Water system	26	Steady legs	54
Safety knob, hinged window	63	Extending	54
Safety net, pull-down bed	75	Length, adjustment	54
Safety/drainage valve boiler	115	Retracting	54
Position	116, 140	Stopcocks, heating circuits	110
Sanitary fittings	131	Sunroof	
Satellite unit	73	Closing	65
With automatic antenna alignment	73	Insect screen	66
Seat belts	44	Opening	65
Cleaning	144	Roman shade	66
Fastening correctly	44	Supports see steady legs	54
Seating arrangement	47	Switching automatics, gas system	83
Seats, rotating	70		

Symbols	
For instructions	17
Gas isolator taps	82, 105
Synthetic parts in the toilet and living areas, cleaning	144
T	
Table	71
Table-top	
Moving	71
Rotating	71
Tank lid see fuel filler neck	51
Technical data	187
Television	37
Securing	37
Storing	37, 38
Thetford toilet	
Flushing	138
Fuse	101
Indicator lamp	138
Tightening torque, wheels	170
Toilet	137
Temporary lay-up	140
Troubleshooting	183
Winter operation	139
Toilet compartment	136
Ventilation	136
Total discharge	85
Towing	24, 51
General instructions	36
Safety instructions	24
Towing eye, installing	52
Transformer/rectifier (EBL 99)	90
Functions	91
Position	91
Travel cots suitable for children	74, 75
Troubleshooting	175
12 V power supply	176
240 V connection	175
Battery	176
Body	184
Braking system	175
Electrical system	175
Entrance step	175
Furniture flaps	184
Gas cooker	178
Gas system	177
Heater	178
Inner door	184
Lighting	175
Living area battery	176
Refrigerator	179, 180
Starter battery	176
Thetford toilet	183
Water supply	183
TV unit	72
Tyre change see changing wheels	169
Tyre specifications	169
Tyres	167
Excessive wear	23, 39, 167, 172
General instructions	167
Handling	169
Identification	169
Load-carrying capacity	170
Tyre pressure	172
Tyre selection	168
U	
Underbody, maintenance	143
Underfloor sliding drawer	
Load	35
Opening	61
Unladen weight	28
Upholstery, cleaning	144
V	
Vehicle identification plate	164
Vehicle lighting see lighting	155
Vehicle, washing	142
Ventilation	61
Toilet compartment	136
Volume of waste water, displaying	95
Volume of water, displaying	95
W	
Wardrobe light	163
Warning stickers	165
Warning tone, entrance step	36
Warranty stamp	3
Washer fluid, filling	50
Washing with a high-pressure cleaner	141
Waste gas vent on the right hand side of the vehicle.	106, 115
Waste water hose	135
Waste water tank	134
Care	143
Cleaning	143

Drain cock	134	Roman shade	69
Emptying	135	Troubleshooting	184
Filling level, displaying	95	Winter care	147
Tank alarm	96	Writing and reading rest	49
Troubleshooting	183		
Water ingress test	4		
Record	7, 8, 9		
Water pipes, cleaning	146		
Water pump	131, 135		
Water supply			
General	131		
Troubleshooting	183		
Water system			
Care	146		
Cleaning	146		
Disinfect	147		
Drinking water filler neck	132		
Emptying	136		
Filling	135		
Safety instructions	26		
Water tank			
Cleaning	146		
Drinking water filler neck	132		
Filling	133		
Filling level, displaying	95		
Safety overflow	133		
Tank alarm	96		
Water, draining	134		
Water, filling with	133		
Weatherproof guarantee	4		
Inspection stamp	7, 8, 9		
Weight details for special equipment	185		
Wheel chocks	53		
Wheel rim size	170		
Wheel rim type	167		
Wheels	167		
Window winder			
Closing	48		
Opening	48		
Windows	62		
Insect screen	65		
Roman shade	65		
Windows, cleaning	142		
Windscreen, blind	48		
Wind-up skylight	69		
Closing	69		
Insect screen	70		
Opening	69		

